

Panasonic®

Multimedia Projection Display Operating Instructions

Models No. **PT-50LC13/PT-60LC13**



MultiMediaCard™



For assistance, please call :
1-888-VIEW PTV(843-9788)
or send e-mail to :
consumerproducts@panasonic.com
or visit us at **www.panasonic.com**
(USA)

For assistance, please call :
787-750-4300
or visit us at **www.panasonic.com**
(Puerto Rico)

Three Important Reasons to Register Your Product Immediately!

- 1 Protect Your New Investment...**
Register your new projection display for insurance purposes in case your new projection display is stolen.
- 2 Product safety notification...**
Registering your product can help us to contact you in the unlikely event a safety notification is required under the Consumer Product Safety Act.
- 3 Improved Product Development...**
Help us continue to design products that meet your needs. Register online at **www.panasonic.com/register**



As an ENERGY STAR® Partner, Matsushita Electric Corporation of America has determined that this product or product model meets the ENERGY STAR® guidelines for energy efficiency.

This operating instruction book is designed for use with models PT-50LC13 and PT-60LC13. Illustrations in this manual show the PT-50LC13.

Before connecting, operating or adjusting this product, please read the instructions completely. Please keep this manual for future reference.

IMPORTANT SAFETY INSTRUCTIONS

	CAUTION RISK OF ELECTRIC SHOCK DO NOT OPEN	
WARNING: To reduce the risk of electric shock, do not remove cover or back. No user-serviceable parts inside. Refer servicing to qualified service personnel.		



This symbol warns the user that uninsulated voltage within the unit may have sufficient magnitude to cause electric shock. Therefore, it is dangerous to make any kind of contact with any inside part of this unit.



This symbol alerts the user that important literature concerning the operation and maintenance of this unit has been included. Therefore, it should be read carefully in order to avoid any problems.



The pictorial representation of a hot surface within a triangle is intended to tell the user that parts inside the product are a risk of burns to persons.

Note to CATV System Installer:

This reminder is provided to call the CATV system installer's attention to Article 820-40 of the NEC that provides guidelines for proper grounding and, in particular, specifies that the cable ground shall be connected to the grounding system of the building, as close to the point of cable entry as practical.

WARNING

- To reduce the risk of electric shock, fire, injury to persons or damage to this product:

- 1) **Read these instructions** before using, connecting or adjusting this product.
- 2) **Keep these instructions** for future reference.
- 3) **Heed all warnings** on the product and in this Operating Instructions manual.
- 4) **Follow all instructions** carefully.
- 5) **Do not use this product near water.** For example, near a bathtub, washbowl, kitchen sink, or laundry tub, in a wet basement or near a swimming pool, and the like. **Do not** place objects filled with water, such as a vase or the like, on top of this unit.
- 6) **Clean only with a dry cloth.** Do not use liquid cleaners or aerosol cleaners.
- 7) **Do not block any ventilation openings. Install in accordance with the manufacturer's instructions.** Openings in the cabinet are provided for ventilation to ensure reliable operation and to protect it from overheating. Never block openings by placing the product on a bed, sofa or similar surfaces.
- 8) **Do not install near any heat source such as radiators, heat registers, stoves, or other apparatus (including amplifiers) that produces heat. Do not** install in a built-in installation such as a bookcase or rack, unless proper ventilation is provided or the manufacturer's instructions have been adhered to.
- 9) **Do not defeat the safety purpose of the polarized or grounding-type plug. A polarized plug has two blades with one wider than the other. A grounding type plug has two blades and a third grounding prong. The wide blade or the third prong are provided for your safety. If the provided plug does not fit into your outlet, consult an electrician for replacement of the obsolete outlet.**
- 10) **Protect the power cord from being walked on or pinched particularly at plugs, convenience receptacles, and the point where they exit from the apparatus.**
- 11) **Use only attachments/accessories specified by the manufacturer.**
- 12) **Use only with the cart, stand, tripod, bracket, or table specified by the manufacturer, or sold with the apparatus. When a cart is used, use caution when moving the cart/apparatus combination to avoid injury from tip-over.**
- 13) **Unplug this apparatus during lightning storms or when unused for long periods of time.**
- 14) **Refer all servicing to qualified personnel. Servicing is required when the apparatus has been damaged in any way, such as power-supply cord or plug is damaged, liquid has been spilled or objects have fallen into the apparatus, the apparatus has been exposed to rain or moisture, does not operate normally, or has been dropped.**
- 15) Because the temperature of the lamp unit is elevated immediately after its use, a direct touch to it may cause burns. **Replace the lamp unit only after it has cooled.**



IMPORTANT SAFETY INSTRUCTIONS (CONTINUED)

WARNING

AS WITH ANY SMALL OBJECT, SD CARDS CAN BE SWALLOWED BY YOUNG CHILDREN. DO NOT ALLOW CHILDREN TO HANDLE THE SD CARD.

CAUTION

- (1) This projection display is intended to be used with the following TV stand: model TY-50LC13C for the PT-50LC13/PT-60LC13. Use with other stands may result in the projection display becoming unstable, possibly causing injury.
- (2) This projection display should not be exposed to direct sunlight, extreme temperatures or moisture, as this can result in serious irreparable damage.
- (3) This product has a High Intensity Discharge (HID) lamp that contains a small amount of mercury. It also contains lead in some components. Disposal of these materials may be regulated in your community due to environmental considerations. For disposal or recycling information please contact your local authorities, or the Electronics Industries Alliance: <<http://www.eiae.org>.>

The lamp has a maximum life of about 10 000 hours.

If use exceeds this figure, the possibility of lamp damage becomes greater.

The lamp should be changed as soon as possible once the lamp warning message appears.

If the lamp is damaged, please contact your nearest dealer.

Due to the characteristics and use conditions of individual lamps, the lamp may cease to light before the stated lamp life.

Influences of frequent lighting, continuous light use for over 24 hours, the number of times lit, the length of time between lightings, etc. may shorten lamp life.

(Because of this, we recommend having a replacement lamp on hand.)

Trademarks

- VGA and XGA are trademarks of International Business Machines Corporation.
 - Macintosh is a registered trademark of Apple Computer, USA.
 - VESA and SVGA are trademarks of the Video Electronics Standard Association.
- Even if no special notation has been made of company or product trademarks, these trademarks have been fully respected.
- Equipped with **dbx**[®]-TV Noise Reduction for true MTS reproduction. **dbx**[®]-TV Noise Reduction is required for good stereo separation and audio fidelity. **dbx**[®] is a registered trademark, and is licensed by **dbx**[®] Technology Licensing.

BBE[®]
High Definition Sound

Manufactured under license from BBE Sound, Inc.

Licensed by BBE Sound, Inc. under USP4638258 and 4482866.

BBE and BBE symbol are registered trademarks of BBE Sound, Inc.

Dear Panasonic Customer

Welcome to the Panasonic family of customers. We hope that you will have many years of enjoyment from your new projection display.

To obtain maximum benefit from your set, please read these Instructions before making any adjustments, and retain them for future reference.

Retain your purchase receipt also, and record the serial number of your set in the space provided on the rear cover of these instructions.

Visit our Panasonic Web Site for USA : www.panasonic.com

For assistance, please call : 1-888-VIEW PTV(843-9788)

or send e-mail to : consumerproducts@panasonic.com

or visit us at www.panasonic.com

(USA)

For assistance, please call : 787-750-4300

or visit us at www.panasonic.com

(Puerto Rico)

FCC STATEMENT:

NOTE:

This equipment has been tested and found to comply with the limits for a Class B digital device, pursuant to Part 15 of the FCC Rules. These limits are designed to provide reasonable protection against harmful interference in a residential installation. This equipment generates, uses and can radiate radio frequency energy and, if not installed and used in accordance with the instructions, may cause harmful interference to radio communications. However, there is no guarantee that interference will not occur in a particular installation. If this equipment does cause harmful interference to radio or television reception, which can be determined by turning the equipment off and on, the user is encouraged to try to correct the interference by one or more of the following measures:

- Reorient or relocate the receiving antenna.
- Increase the separation between the equipment and receiver.
- Connect the equipment into an outlet on a circuit different from that to which the receiver is connected.
- Consult the dealer or an experienced radio / TV technician for help.

FCC CAUTION:

To assure continued compliance and prevent undesirable interference, use only the provided shielded RGB cable/DVI cable with 2 ferrite cores while connecting the projection display to a computer. Any changes or modifications not expressly approved by the party responsible for compliance could void the user's authority to operate this equipment.

Declaration of Conformity

Models Number: **PT-50LC13/PT-60LC13**

Trade Name: Panasonic

Responsible party: Matsushita Electric Corporation of America.

Address: One Panasonic Way Secaucus New Jersey 07094

Telephone number: 1-888-VIEW PTV(843-9788)

This device complies with Part 15 of the FCC Rules. Operation is subject to the following two conditions: (1) This device may not cause harmful interference, and (2) this device must accept any interference received, including interference that may cause undesired operation.

Table of Contents

To
Start !

Important Safety Instructions	2
Before Using	6
Receiver Location	6
Optional External Equipment	6
Safety Precaution.....	6
Viewing position	6
Accessories.....	7
Remote Control Battery Installation	7
Location of Controls	8
Illuminated Remote Control.....	8
Controls and Terminals on the projection display	10
Installation	12
Connecting the Antenna / Cable to the RF in Terminal (No VCR).....	12
Connecting the Antenna / Cable to the RF in Terminal (VCR).....	14
How to connect the “1, 2, 3” Input Terminals	15
How to connect the COMPONENT VIDEO Input Terminals.....	16
How to connect the AV Out Terminals	17
How to connect the RGB IN Terminals	18
How to connect the DIGITAL IN Terminal	20
RGB/DIGITAL IN signals that can be input.....	21

Use
Now !

Power ON and OFF	22
Initial Setup	22
Turning the Power ON and OFF	23
Flow Chart of Main menu	24
Tuning channels	26
Automatic channel setting	26
Manual channel setting	28
Projection display operation	30
ASPECT Controls	32
Searching for the desired channel (Channel search)	34
Playing peripheral equipment	35
Mute / Freeze / SAP	36
Split screen	38
Picture in Picture (PIP) Screen.....	40

Enjoy
More !

Adjusting screen position and size	42
Audio Adjustments	44
Picture Adjustments	46
Lock Feature	48
Closed Captions	52
Channel Caption Feature	54
Weak Signal Display Feature	55
Video NR (Noise Reduction) Feature	56
Automatically changing screen size	57
Setting when 480p signals are input through COMPONENT VIDEO INPUT	57
RGB/DIGITAL IN Input Feature	58
3D Y/C Feature	59
3D IP Feature	59
Sleep Timer Feature	60
Switching languages for display	61
Information	61
Demo Mode Feature	62
JPEG Viewer (SD Card/PC Card)	63

Other
Information !

Replacing the lamp unit	68
Remote Control Quick Reference Guide (Operating peripheral equipment)	69
Troubleshooting	76
Specifications	77
Cleaning	78
Customer Services Directory	78
Limited Warranty	79
Index	Back cover

Getting Started

Basic Operation

Advanced Operation

Information

Before Using

Receiver Location

This projection display is intended to be used with an optional stand or entertainment center. Consult your dealer for available options.

Locate for comfortable viewing. Avoid placing where sunlight or other bright light (including reflections) will fall on the screen.

Use of some types of fluorescent lighting can reduce remote control transmitter range.

Adequate ventilation is essential to prevent internal component failure. Keep away from areas of excessive heat or moisture.

Optional External Equipment

The Video / Audio connection between components can be made with shielded video and audio cables. For best performance, video cables should utilize 75 Ω coaxial shielded cables. Cables are available from your dealer or electronic supply house.

Before you purchase any cables, be sure you know what type of output and input connectors your various components require. Also determine the length of cable you'll need.

Safety Precaution

Please take safety precautions to prevent the unit from falling over.

⚠ WARNING

The unit may tip or fall if not situated on a stable surface, if pushed or during an earthquake. Use a strong rope or chain (not included) to fasten the projection display firmly to a strong wall support.

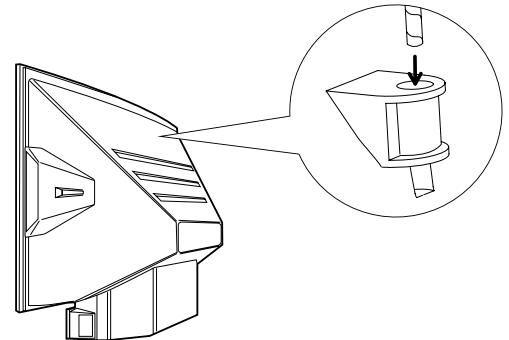

Viewing position

To optimize your viewing comfort, please follow the viewing guidelines shown in the diagrams below. If viewing for an extended period of time, sit as far back from the screen as possible.

<Top view>

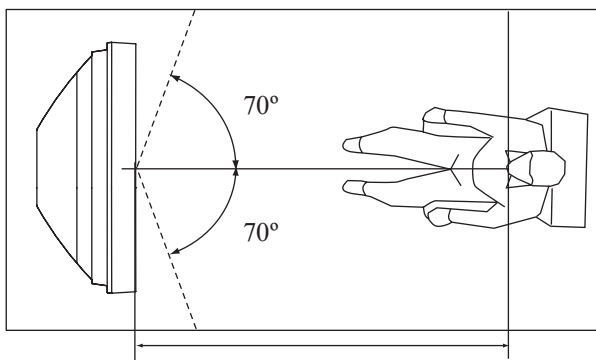

At least 1.8 m (PT-50LC13)/2.2 m (PT-60LC13).

<Side view>

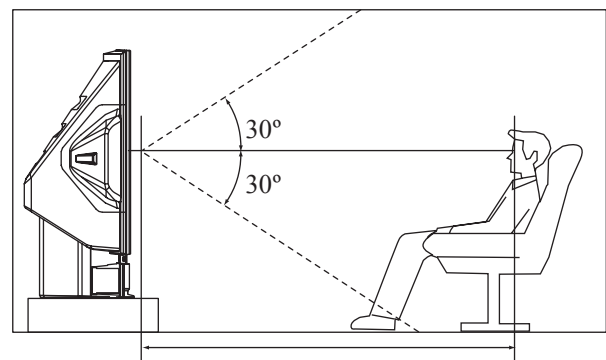

At least 1.8 m (PT-50LC13)/2.2 m (PT-60LC13).

Accessories

1. Remote Control (EUR7603ZB0)
2. Batteries 2 "AA"
3. RGB Cable (2 m) (LSJA0239-1 or LSJA0443)
4. DVI Cable (2 m) (K1HA24DA0003)

Remote Control Battery Installation

Requires two AA batteries (supplied).

1. Turn the Transmitter face down. Remove top cover by pressing down on marking and sliding cover off in the direction indicated.
2. Install the batteries as shown in the battery compartment. (Polarity + or - must match the markings in the compartment).
3. Replace the cover and slide in reverse until the lock snaps.

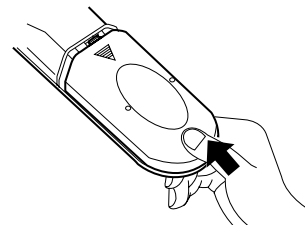
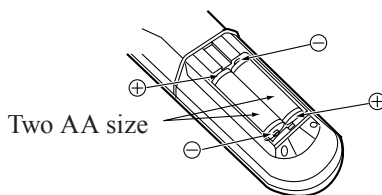
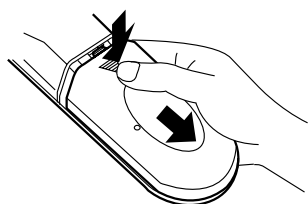

⚠ CAUTION

Incorrect battery installation can cause the batteries to leak, leading to personal injury and/or damage to the remote control.

Observe the following precautions:

1. Batteries should always be replaced as a pair. Always use new batteries when replacing the old set.
2. Do not mix battery types (example: "Zinc Carbon" with "Alkaline").
3. Do not attempt to charge, short-circuit, disassemble, heat or burn used batteries.
4. Battery replacement is necessary when the remote control acts sporadically or stops operating the projection display set.

Helpful Hints:

- (1) For frequent remote control users, replace old batteries with Alkaline batteries for longer battery life.
- (2) Whenever you remove the batteries, **you may need to reset the remote control infrared codes.** We recommend that you record the code on page 70, prior to setting up the remote.

Location of Controls

Illuminated Remote Control

POWER button —
Press to turn the projection display ON or OFF. (P. 22)

MUTE button —
Press this button to mute the sound. (P. 36)

Mode Selection buttons

Selects the operation mode for the remote control. (PP. 69-75)

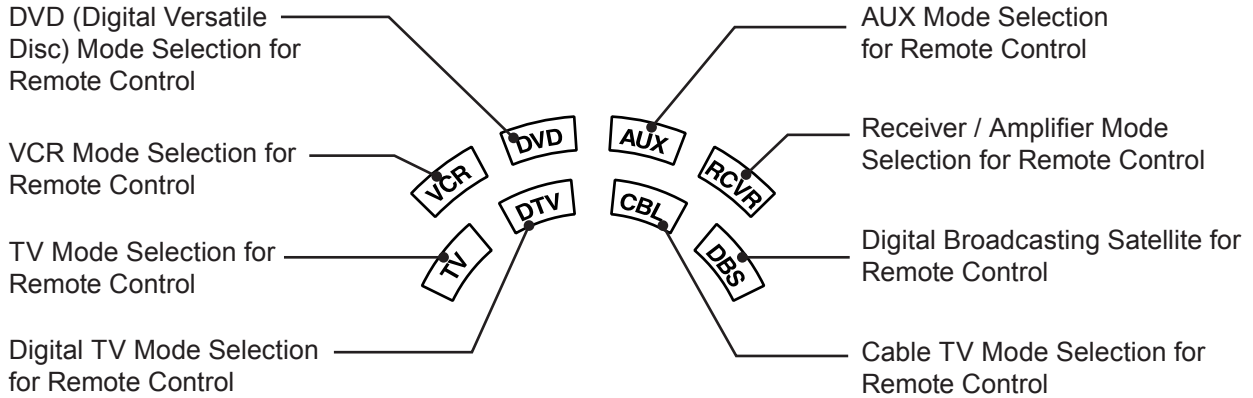

PC/MENU button —
RGB input mode is displayed.
Toggles between RGB1 and RGB2 input mode. (P. 35)

Number keys —
When 6 is pressed, channel 6 is displayed in single screen. (P. 31)

R-TUNE button —
Press to view previous channel or video mode.

Function buttons

PIP MIN REW 		PIP MAX FF 	FREEZE TV/VCR 	PIP CH VCR CH 	PIP CH VCR CH
PIP MIN (P. 41)	SD (P. 35)	PIP MAX (P. 41)	FREEZE (P. 36)	PIP/SPLIT CH Down (PP. 39, 41)	PIP/SPLIT CH Up (PP. 39, 41)
SEARCH OPEN/CLOSE 	PIP 	SPLIT 	MOVE 	SWAP 	
CH Search (P. 34)	PIP (P. 40)	SPLIT (P. 38)	PIP MOVE (P. 41)	PIP/SPLIT SWAP (PP. 39, 41)	

Location of Controls

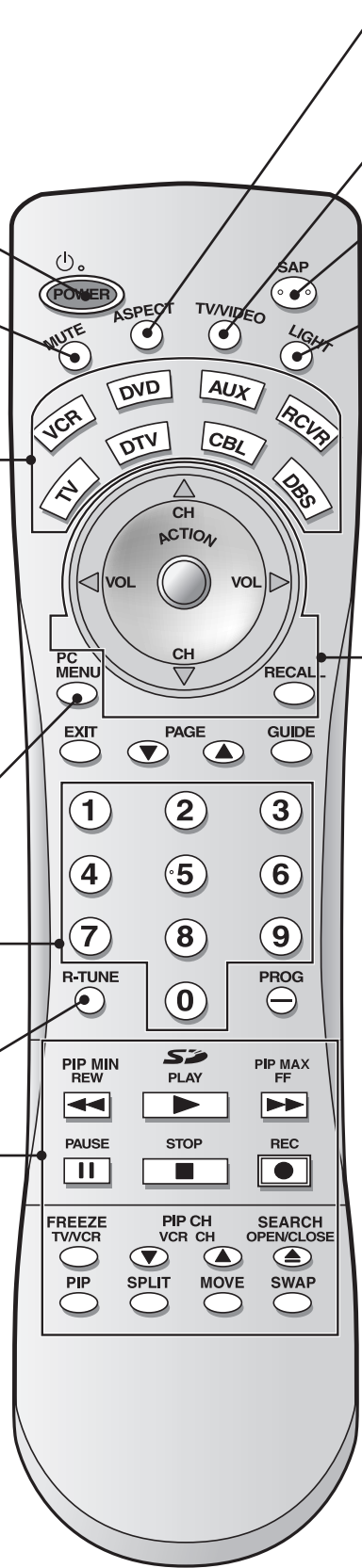

- ASPECT button**
Changes the way the image is displayed. (P. 32)
- TV/VIDEO button**
Toggles between TV and VIDEO inputs. (P. 35)
- SAP button**
Changes the audio mode. (P. 37)
- Light button**
Lights all buttons. The selected mode button (TV, VCR, etc.) flashes.

Display menu
Press the ACTION button to display Menu screen.

The screen below is displayed for 5 seconds. (P. 31)

CH 12
ABC

NORMAL
STEREO ←
SAP
MONO

When the Menu screen is displayed, (PP. 24-25)

Note:
This section describes TV mode only. For other modes, see pages 69-75.

Location of Controls

Controls and Terminals on the projection display

Model PT-50LC13 unit shown

< FRONT >

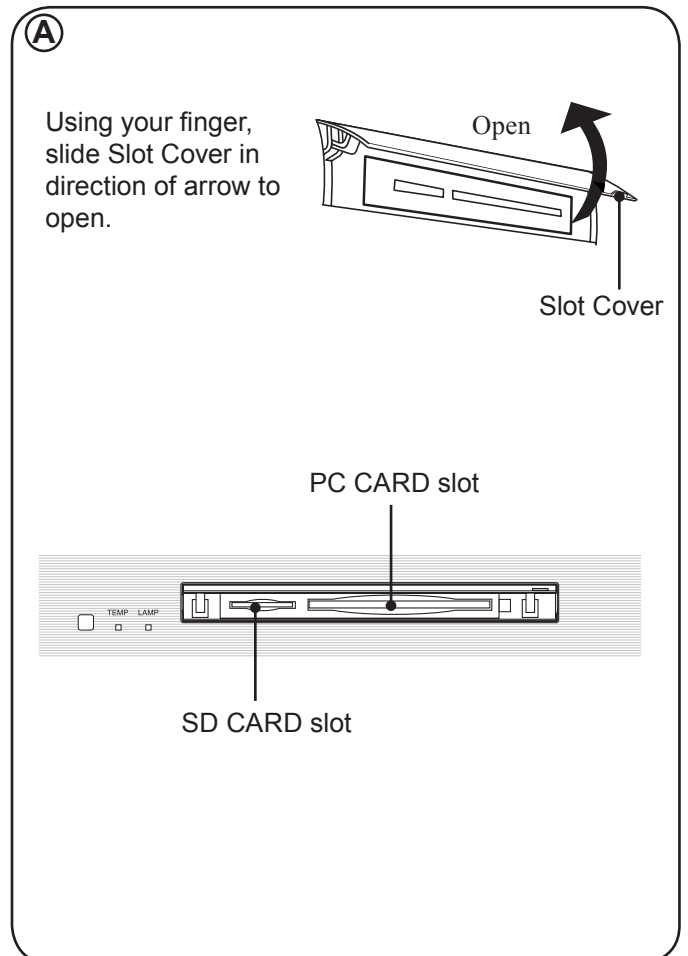
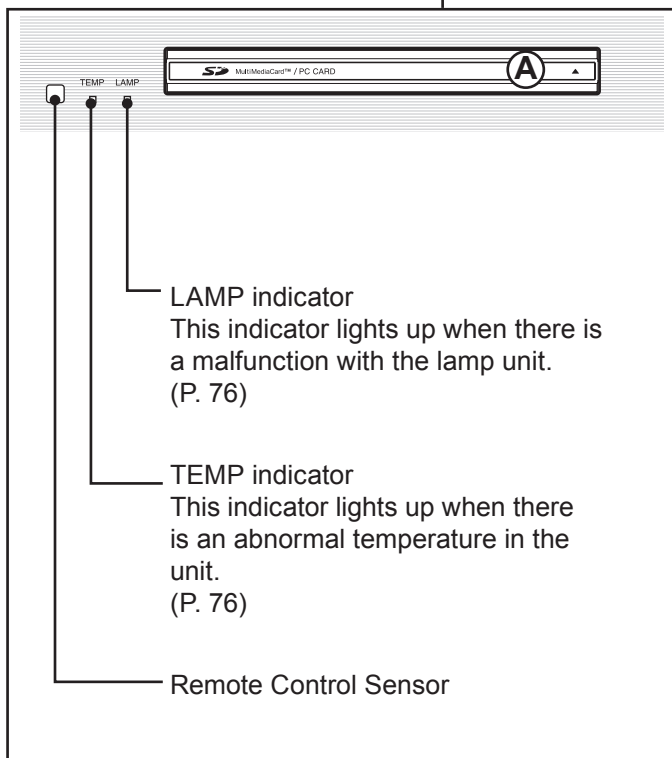
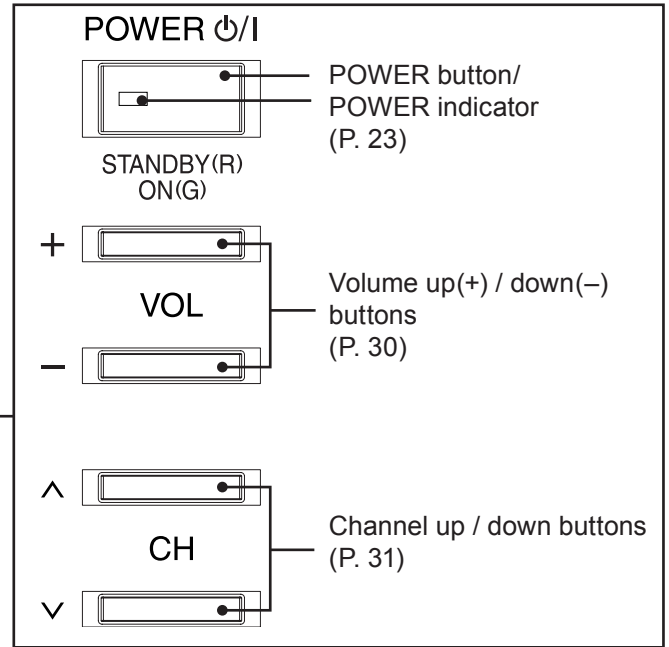
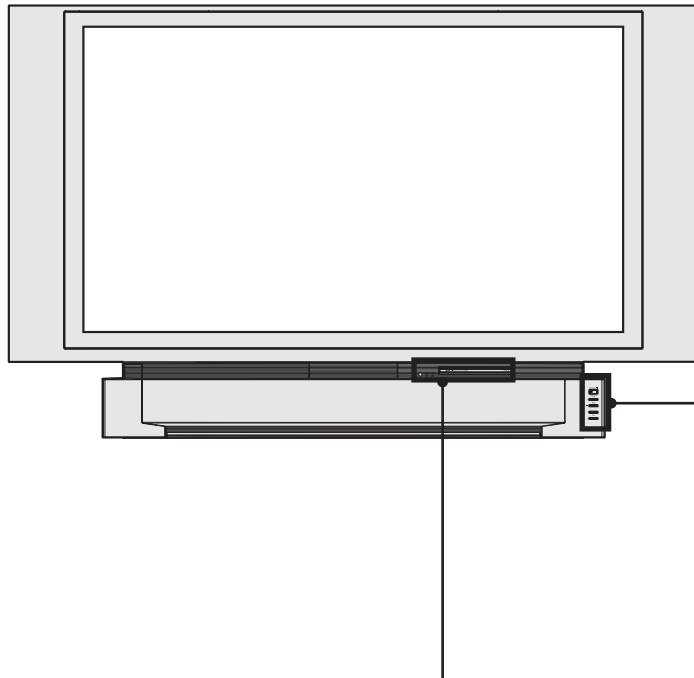

Model PT-50LC13 unit shown

< REAR >

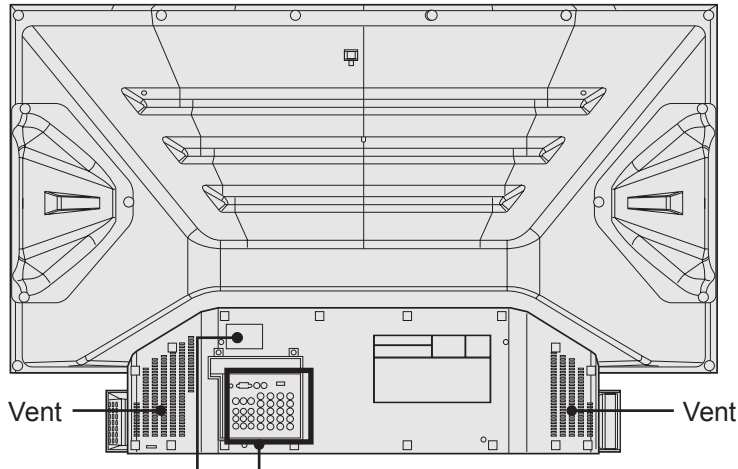

< SIDE >

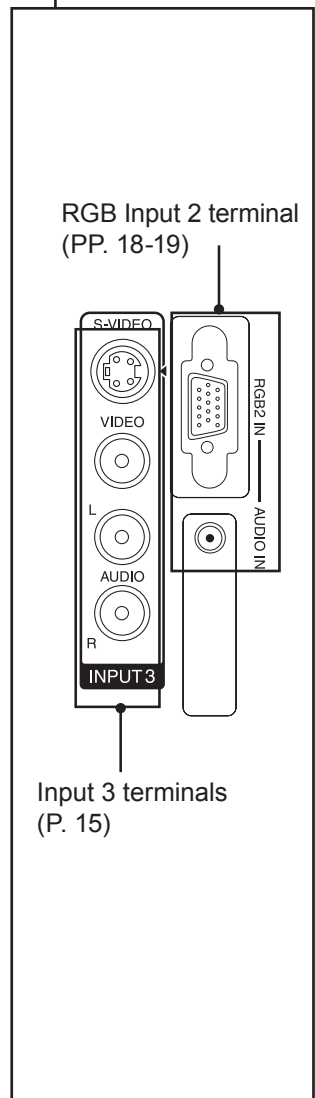
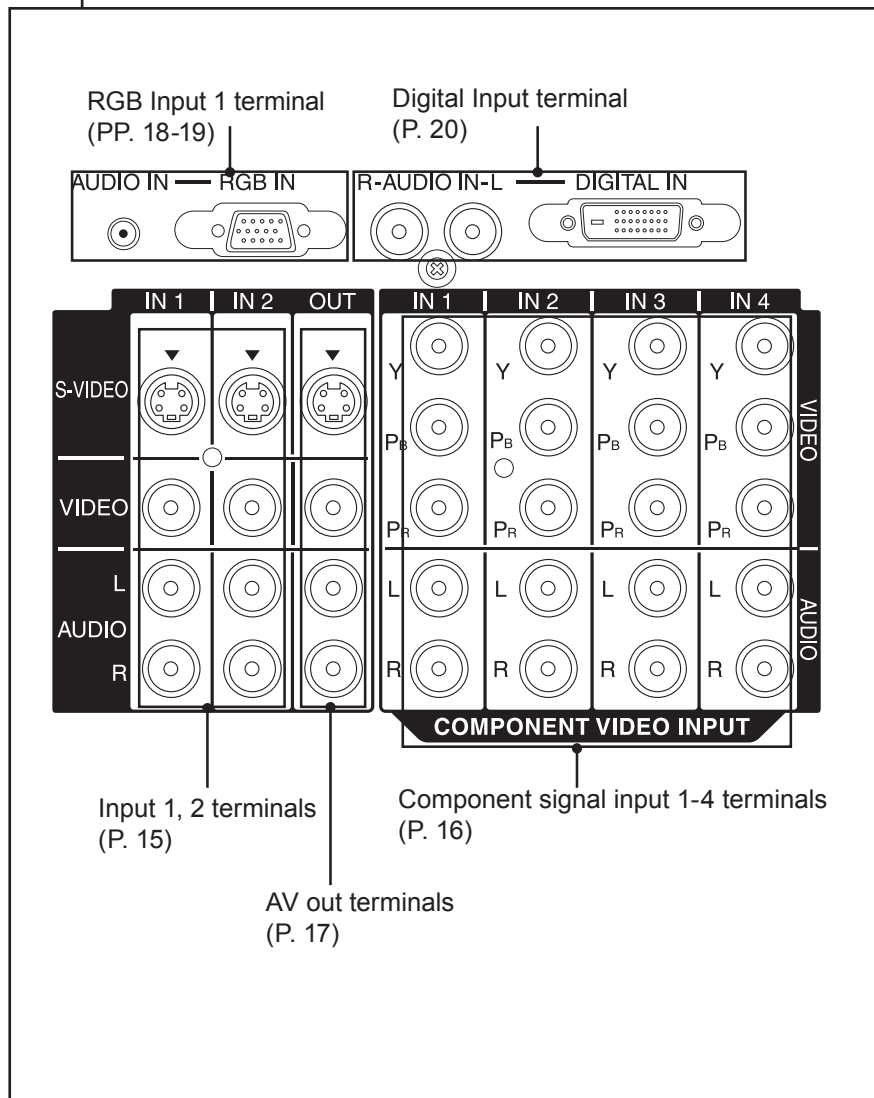
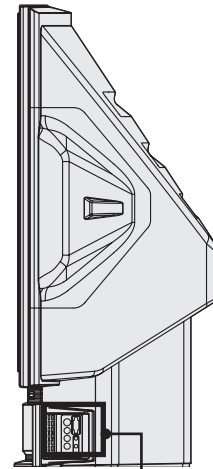

Note:
Make sure the vents are not blocked. (This could cause damage.)

Installation

Notes on connections

- Turn off the power supply for all components before making any connections.
- If the cables necessary for connecting a component to the system are not included with the component or available as an option, you may need to fashion a cable to suit the component concerned.
- Read the instruction manual for each system component carefully before connecting it.
- If there is a lot of jitter in the video signal input from the video source, the picture on the screen may flicker. In this case, it will be necessary to connect a TBC (time base corrector).

Connecting the Antenna / Cable to the RF in Terminal (No VCR)

Antenna Connection

For proper reception of VHF / UHF channels, an external antenna is required. For best reception an outdoor antenna is recommended.

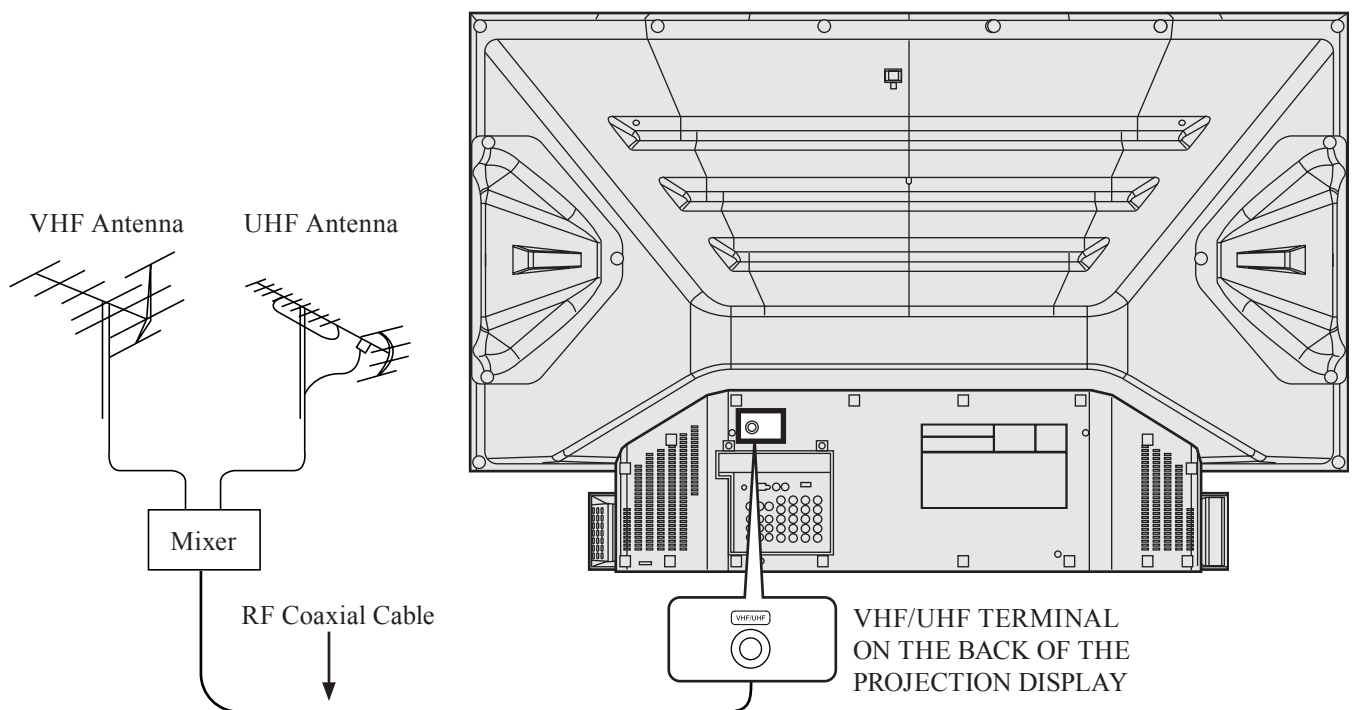

⚠ CAUTION

When using “Nut type” RF coaxial cables, tighten with fingers only. Overtightening may damage terminals.

Cable Connection

Use this configuration when connecting the projection display to a cable TV system.

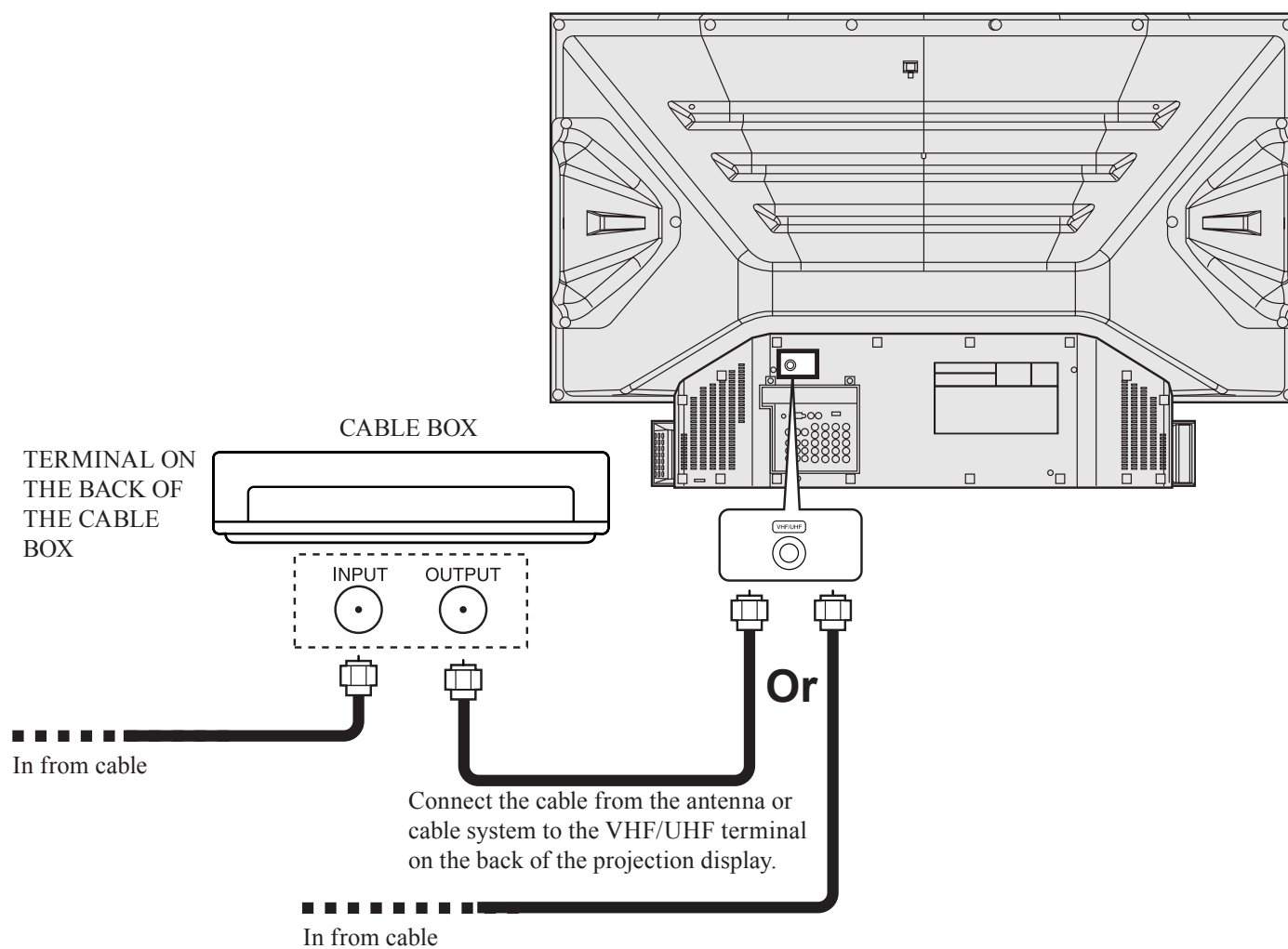

Notes:

- Certain cable systems offset some channels to reduce interference or have Premium (scrambled) channels. A cable converter box is required for proper reception. Check with your local Cable company for its compatibility requirements.
- For reception of cable channels (01 - 125) connect the cable supplied by your local cable company. Antenna Mode must be set to CABLE. (P. 26)

Installation

Connecting the Antenna / Cable to the RF in Terminal (VCR)

Use this configuration when connecting the projection display to a cable TV system using VCR.

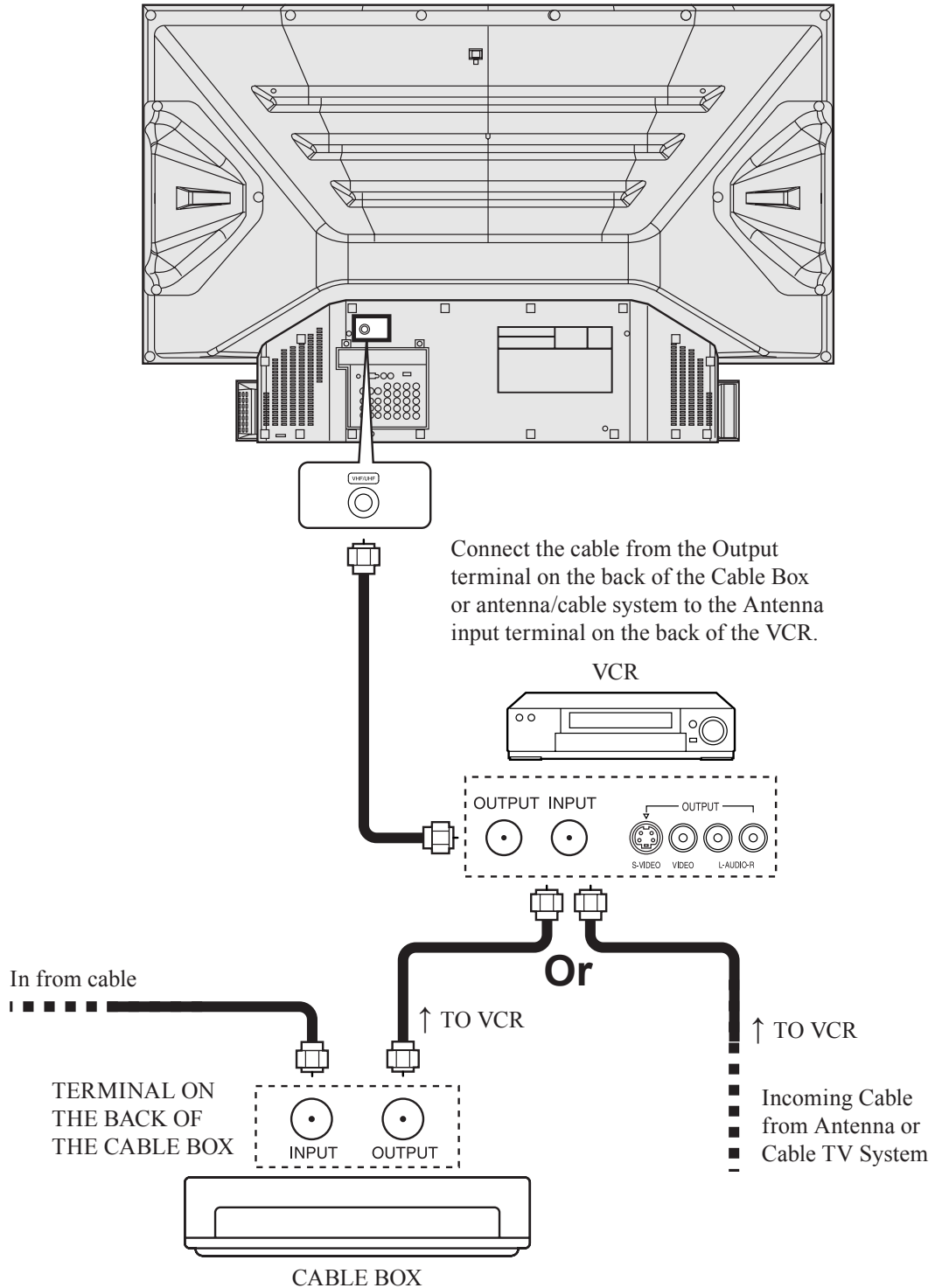

Note:

When the RF coaxial cable is connected to the projection display VHF/UHF terminal via a cable box or VCR, set the TV channel to CH3 or CH4. This does not apply when signal is input from VIDEO INPUT.

How to connect the “1, 2, 3” Input Terminals

Connects VCRs and other peripheral equipment

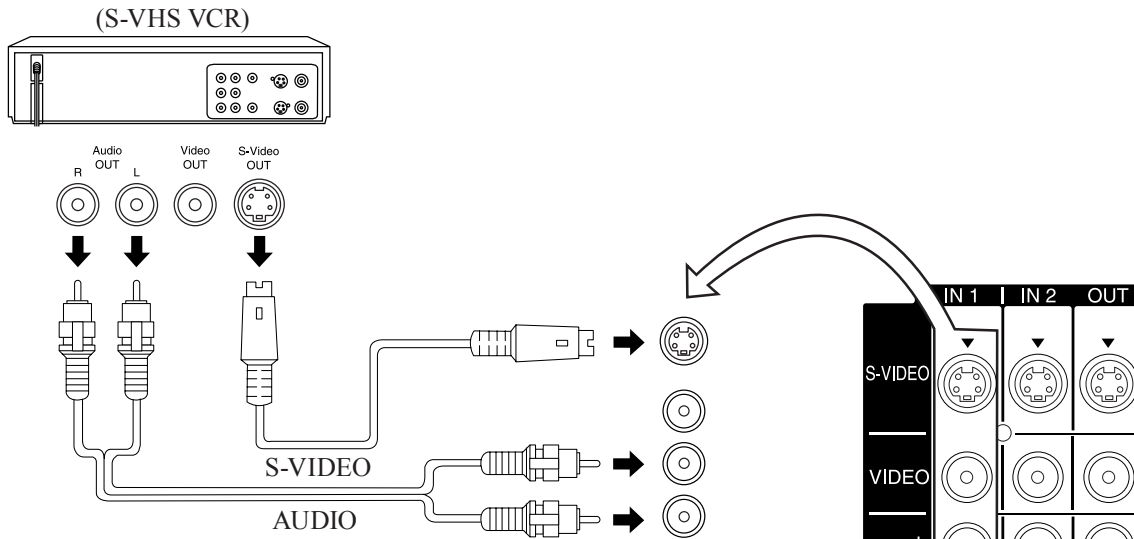

Similar connections are available at the INPUT 1, 2, 3 input terminals. (P. 11)

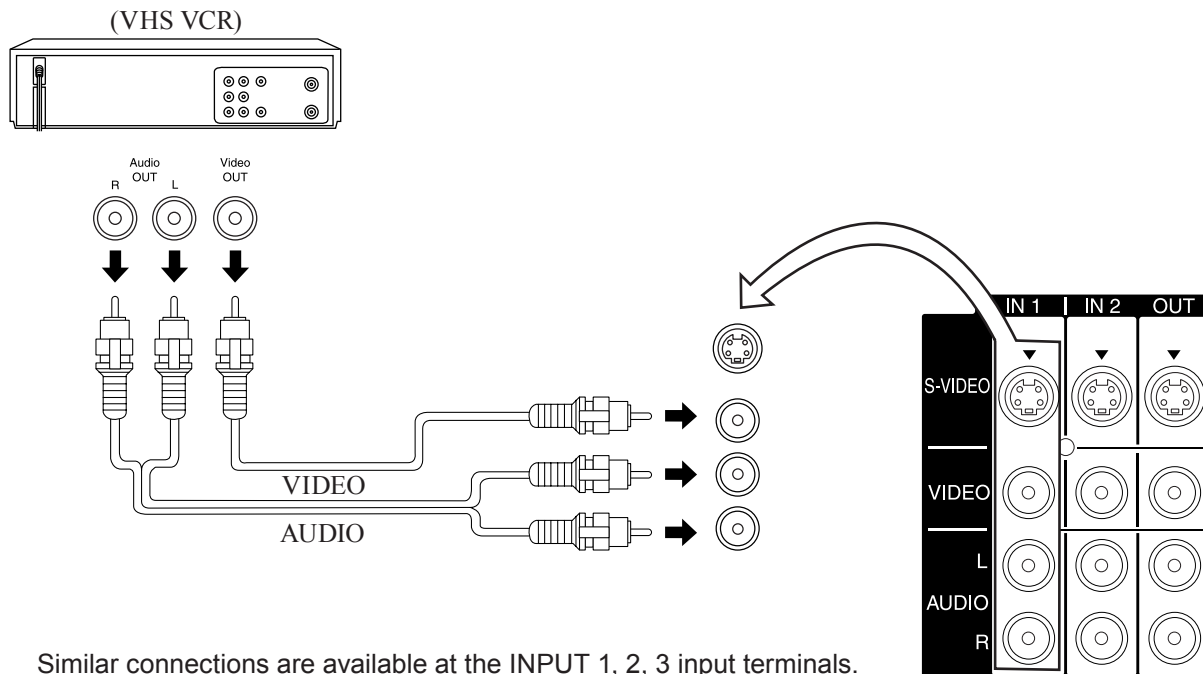

Similar connections are available at the INPUT 1, 2, 3 input terminals.

Notes:

- Similar connections are available at the INPUT 1, 2, 3 input terminals.
- Input 3 is located on the side of the unit.
- Select the desired VIDEO input position by pressing the TV/VIDEO button. (P. 35)
- When connecting video cables, priority is given to the S-Video cable when the S-Video input terminal and the video input terminal are connected at the same time.

Installation

How to connect the COMPONENT VIDEO Input Terminals

Because each Y, PB, and PR signal is input independently, the Component signal allows for more accurate color reproduction.

The Component signal output terminal indication will differ according to the output device (Y, PB, PR). Please read the operating instructions included with the output device.

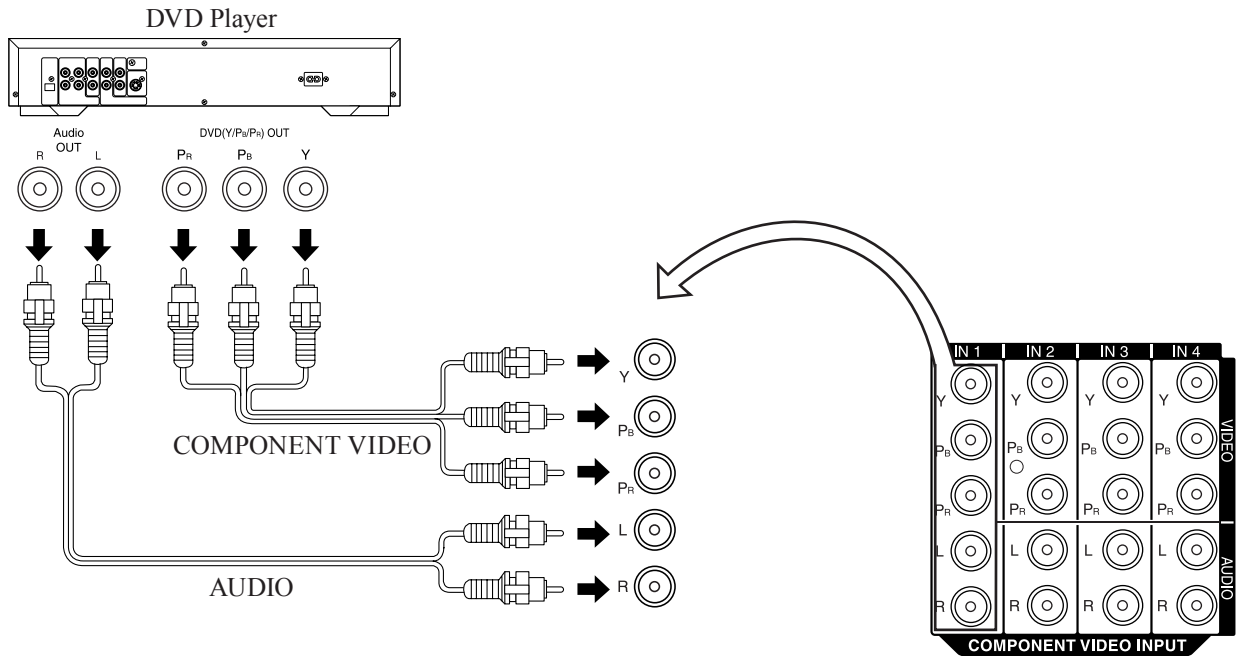

Notes:

- Similar connections are available at the COMPONENT VIDEO INPUT 1-4 Terminals.
- Select the desired COMPONENT VIDEO INPUT position by pressing the TV/VIDEO button. (P. 35)
- Component video signals that can be input are 480i, 480p, 720p, and 1080i.

Component Signals (Y, PB, PR) that can be Input

Mode type		Signal data			Information menu display
		No. of dots (H X V)	Horizontal frequency (kHz)	Vertical frequency (Hz)	
DTV Format Signals	480i	664 X 485	15.73	29.97	480 i
	480p	720 X 483	31.47	59.94	480 p
	720p	1 280 X 720	45.00	60.00	720 p
	*1080i	1 920 X 1 080	33.75	30.00	1080 i

Note:

Input signals, other than those listed with a * mark, will give you a beautiful, stable picture.

How to connect the AV Out Terminals

The "AV Out" Terminals output the same signals as the main picture on the projection display screen and sound from the speaker at that time, e.g. TV programs or signals from INPUT 1, 2, 3 terminals.

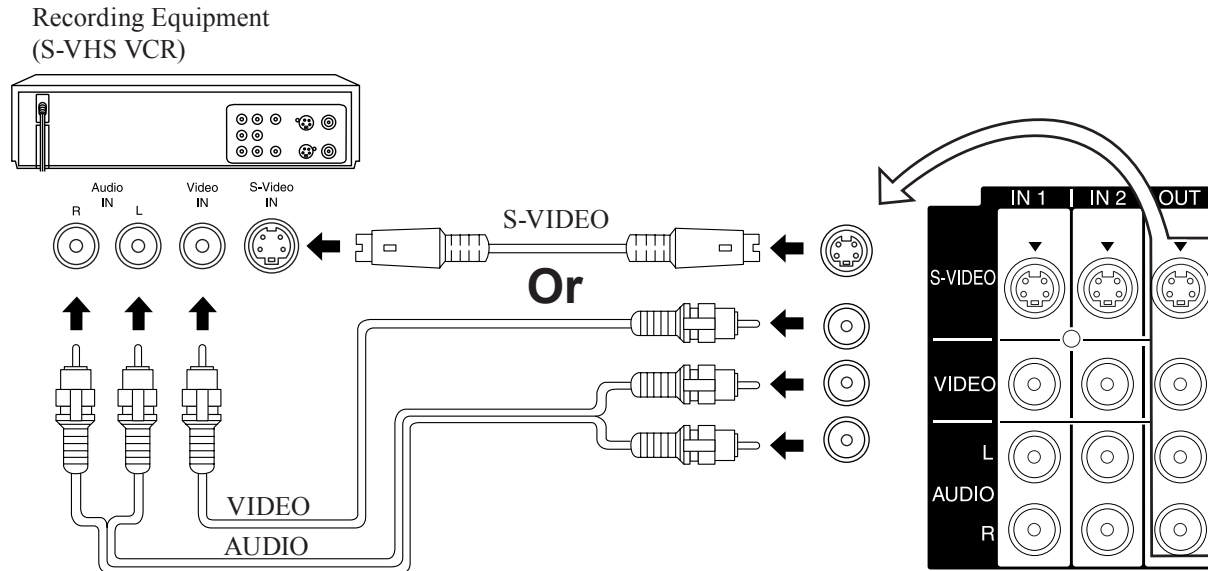

Stereo System
(A Stereo Amplifier and Speakers)

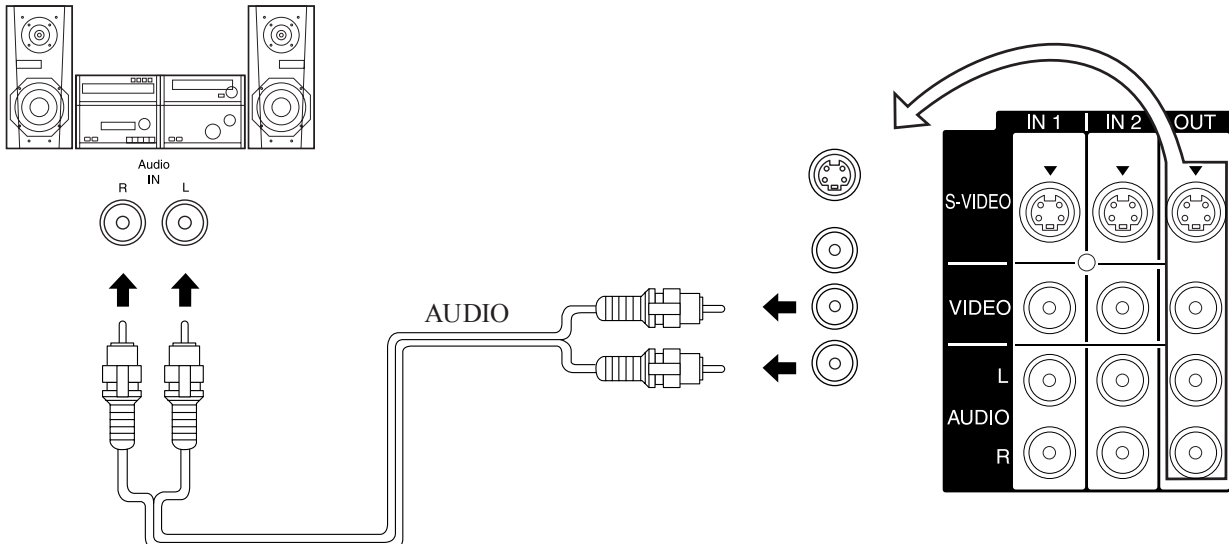

Notes:

- Never connect the VIDEO IN and OUT terminals to the same video recorder, as this could cause incorrect operation.
- Even if TV is in Split or PIP mode, OUT terminals only output the main picture and sound signals. A sub-picture, including channel search, etc., will not be output.
- VIDEO OUT terminals will not output Y, P_B, P_R, RGB/DIGITAL IN or SD/PC card signals.
- The S-Video OUT terminal outputs the same signal that is input from the S-Video IN terminal.

Installation

How to connect the RGB IN Terminals

Connecting a PC to RGB IN

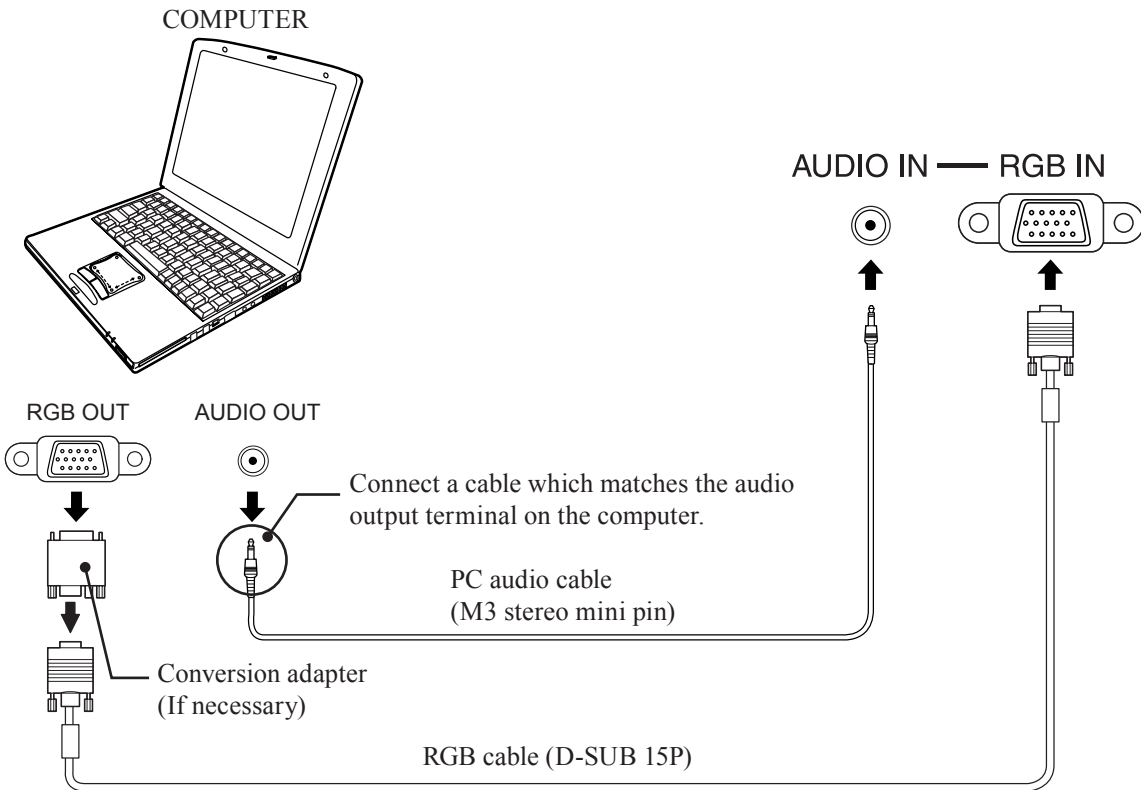

RGB IN Terminal (D-SUB 15P) Pin Layouts

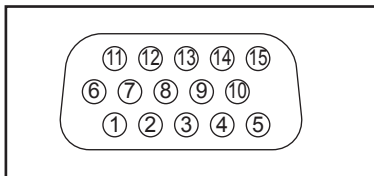

Pin No.	Signal name
1	R
2	G
3	B
4	NC
5	NC
6	Ground for R
7	Ground for G
8	Ground for B

Pin No.	Signal name
9	NC
10	Ground
11	NC
12	NC
13	HD/CSYNC
14	VD
15	NC

NC: Not connected

Notes:

- Some PC models cannot be connected to the set. A conversion adapter is required to use the RGB cable (D-SUB 15P) to connect a Macintosh computer to the set. There is no need to use an adapter for computers with PC / AT compatible D-SUB 15P terminal.
- The computer shown in the illustration is for example purposes only. Additional equipment and cables shown are not supplied with this set.
- The picture will become dark if an PC signal with a vertical scanning frequency of 62 Hz is input. To obtain the optimum picture quality with the projection display, a vertical scanning frequency of 60 Hz is recommended.
- Do not set the horizontal and vertical scanning frequencies for PC signals which are above or below the specified frequency range.
- Select the desired RGB input position by pressing the PC/MENU or TV/VIDEO button. (P. 35)
- Similar connections are available at the RGB IN 1, 2 Terminals.

Connecting a DTV Decoder to RGB IN

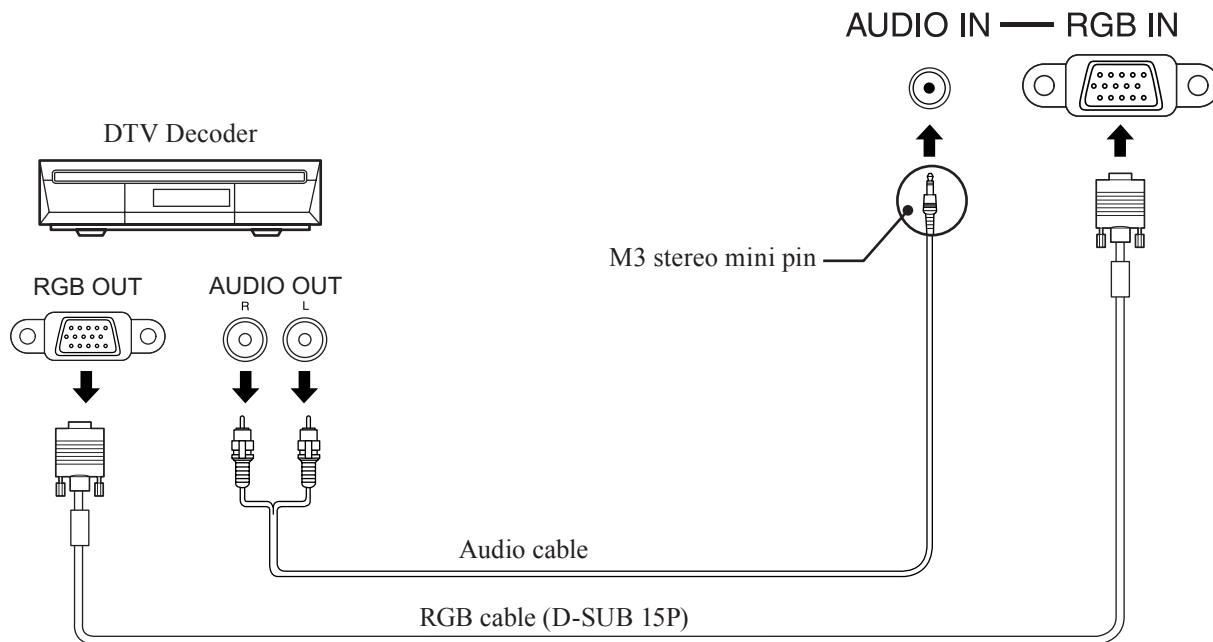

Notes:

- Select the desired RGB input position by pressing the PC/MENU or TV/VIDEO button. (P. 35)
- Similar connections are available at the RGB IN 1, 2 Terminals.

Installation

How to connect the DIGITAL IN Terminal

The video signal is digitally input to the projection display for superior picture quality enjoyment.

Connecting a DTV Decoder to DIGITAL IN

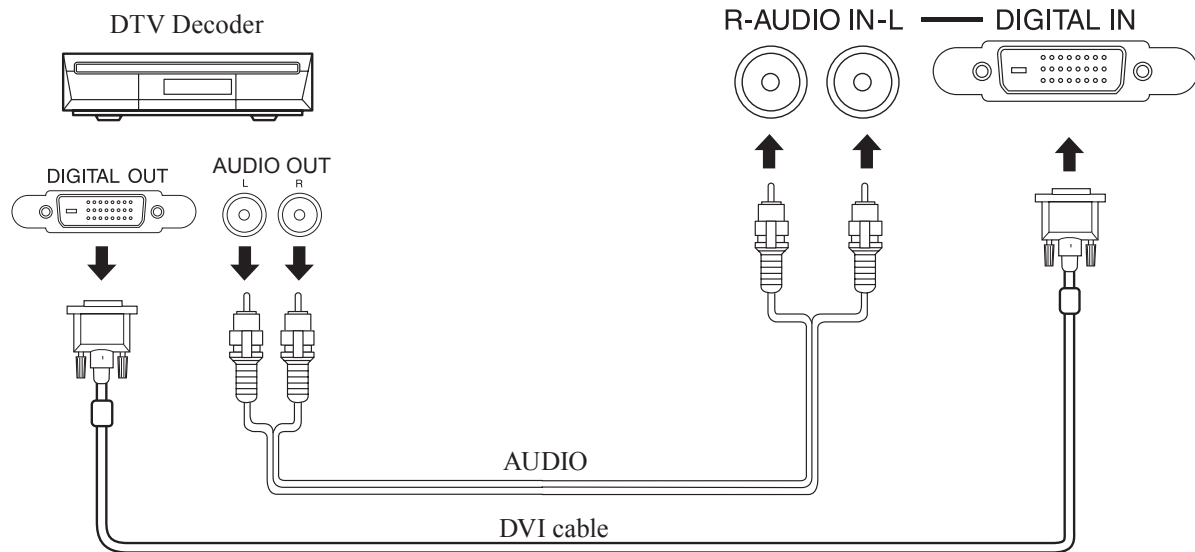

By inputting a High-bandwidth Digital Content Protection high-definition picture source to the DIGITAL IN terminal of this projection display, high-definition pictures can be displayed on the screen in their digital form. (This terminal is for use in the future when High-bandwidth Digital Content Protection DTV decoders, DVD players and D-VHS are put on the market.)

Notes:

- Select the DIGITAL input position by pressing the TV/VIDEO button. (P. 35)
- The DIGITAL IN terminal can only be used with 1080i, 720p and 480p picture signals. Set the DTV Decoder DIGITAL OUT terminal to 1080i, 720p, or 480p signal output. Please refer to the DTV Decoder instruction manual.
- If no picture is displayed because the DTV Decoder output cannot be set, use the component Video Input, S-Video Input, or Video Input. This will display the picture as an analog signal.

DIGITAL IN Terminal Pin Layouts

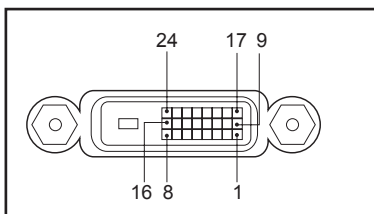

Connection port view

Pin No.	Signal name
1	T.M.D.S Data 2-
2	T.M.D.S Data 2+
3	T.M.D.S Data 2 Shield
4	NC
5	NC
6	DDC Clock
7	DDC Data
8	NC
9	T.M.D.S Data 1-
10	T.M.D.S Data 1+
11	T.M.D.S Data 1 Shield
12	NC

Pin No.	Signal name
13	NC
14	+5 V
15	GND
16	Hot Plug Detect
17	T.M.D.S Data 0-
18	T.M.D.S Data 0+
19	T.M.D.S Data 0 Shield
20	NC
21	NC
22	T.M.D.S Clock Shield
23	T.M.D.S Clock +
24	T.M.D.S Clock -

NC: Not connected

RGB/DIGITAL IN signals that can be input

The table below lists the different types of RGB/DIGITAL IN signals that can be input. If a signal which differs greatly from any of the types listed below is input, the picture image may not be displayed correctly, or a black background may be displayed. At this time, “signal” will flash in the on-screen display for about 5 seconds.

Mode type		Signal data			Information menu display
		No. of dots (H X V)	Horizontal frequency (kHz)	Vertical frequency (Hz)	
Personal Computer Signals	VGA400 (70 Hz) ♦	640 X 400	31.47	70.08	VGA400 70Hz
	VGA480 (60 Hz) ♦	640 X 480	31.47	59.94	VGA 60Hz
	Macintosh 13"	640 X 480	35.00	66.67	MAC 13
	VESA400 (85 Hz)	640 X 400	37.86	85.08	VESA 85Hz
	VESA480 (72 Hz)	640 X 480	37.86	72.81	VGA 72Hz
	VESA480 (75 Hz)	640 X 480	37.50	75.00	VGA 75Hz
	VESA480 (85 Hz)	640 X 480	43.27	85.01	VGA 85Hz
	SVGA (56 Hz)	800 X 600	35.16	56.25	SVGA 56Hz
	SVGA (60 Hz) ♦	800 X 600	37.88	60.32	SVGA 60Hz
	SVGA (72 Hz)	800 X 600	48.08	72.19	SVGA 72Hz
	SVGA (75 Hz)	800 X 600	46.88	75.00	SVGA 75Hz
	SVGA (85 Hz)	800 X 600	53.67	85.06	SVGA 85Hz
	Macintosh 16"	832 X 624	49.73	74.55	MAC 16
	* XGA (60 Hz) ♦	1 024 X 768	48.36	60.00	XGA 60Hz
	* XGA (70 Hz)	1 024 X 768	56.48	70.07	XGA 70Hz
	* XGA (75 Hz)	1 024 X 768	60.02	75.03	XGA 75Hz
* Macintosh 19"	1 024 X 768	60.24	74.93	MAC 19	
DTV Format Signals	480i	664 X 485	15.73	29.97	480 i
	480p ♦	720 X 483	31.47	59.94	480 p
	720p ♦	1 280 X 720	45.00	60.00	720 p
	*1080i ♦	1 920 X 1 080	33.75	30.00	1080 i

Notes:

- Input signals, other than those listed with a * mark, will give you a beautiful, stable picture.
- The D-SUB15P connector can accept RGB (H-V sync separate) and RGB (sync on green). However, it is not guaranteed to display stable color when using RGB (sync on green).
- When used with an external video processor/scaler, it must have RGB (H-V sync separate) output.
- A “♦” mark indicates signals that can be input with DIGITAL IN.
- If your PC (with DIGITAL IN terminal) does not support Plug-and-Play (DDC1/2B) for displays, reconfiguration is required after the projection display is connected to the PC.

Power ON and OFF

Initial Setup

First, check the connection of the Plug to the Wall Outlet and the Antenna/Cable to the RF in Terminal. (PP. 12-14.)

If using Cable Box, DSS Receiver, or VCR,

- Turn on Cable Box.
- Turn off DSS Receiver, or VCR.



Press the POWER button to turn the projection display on. (Refer to page 23 for “Turning the Power ON and OFF”.)

Automatic Channel Setting is performed.

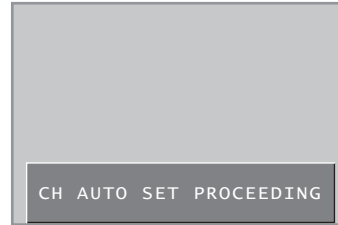

Note:

To cancel AUTO SET in progress, press the SWAP button.

Case 1

When setup is complete, the lowest channel picture appears.

Case 2

If setup is incomplete, the following screen appears. Check connection of Antenna/Cable to the RF in Terminal, then try Automatic Channel Setting again. (PP. 26-27)

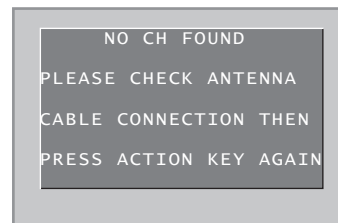

Note:

When the unit is turned on for the first time, Automatic Channel Setting is performed.

Turning the Power ON and OFF

Always be sure to follow the procedure given below to turn the projection display power ON and OFF.

- The lamp cooling fan will continue to operate for approximately 1 minute after the power is turned off. At the same time, the POWER indicator will blink Red.

Do not disconnect the power cord from the outlet and do not open the circuit breaker (unless necessary) while the cooling fan is still operating. Do not disconnect the power cord from the power outlet while the power indicator blinks Red.

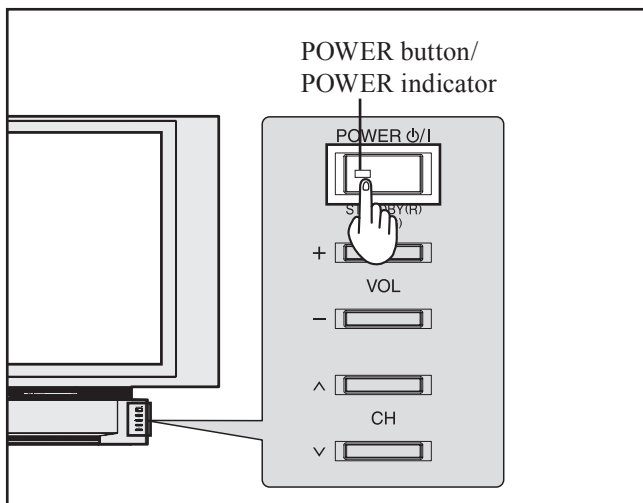

Power ON

Press POWER on projection display or remote control to turn power on.

The Power Indicator blinks Green for about 10 seconds and then turns solid Green.

Power OFF

Press POWER on projection display or remote control to turn power off.

Power shuts off after a Black Screen is displayed for a few seconds.

Note:

If POWER is pressed during the Black Screen display, Power is turned back on.

The Power Indicator blinks Red for about 1 minute and then turns solid Red.

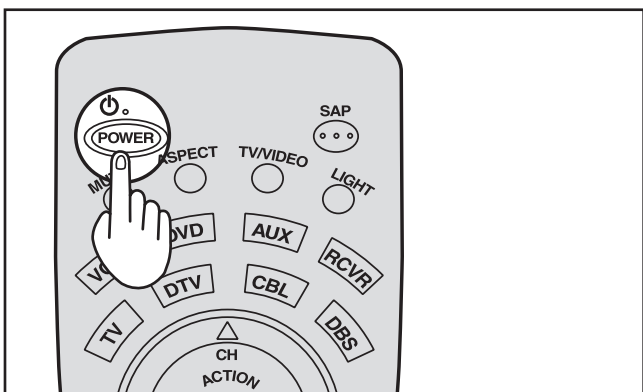

Note:

When the AC Cord is unplugged, the internal cooling fan stops operating. In this case, the lamp will be insufficiently cooled and will take a while to turn ON again.

The Power Indicator

LED	ACTION
Red	Power – OFF (Standby mode)
Red blink	Power – OFF (Now cooling)
Green	Power – ON
Green blink	Power – ON (Preparing to light lamp)

Notes:

- If the POWER button is accidentally turned off during use, after power is turned back on, it may take a short period before the lamp automatically comes on.
- After the unit is turned on, maximum picture brightness will be achieved in 5-10 minutes. This is normal.

Flow Chart of Main menu

1

Pressing the ACTION button displays the MENU screen.

ACTION



Note:

Depending on the signal being input, some items may or may not be adjustable and some functions may or may not be available.

2

Select MENU desired by pushing Left “◀” button or Right “▶” button.

Use the ▲, ▼ buttons to select an item.

Use the ACTION button to set or go to next menu screen.

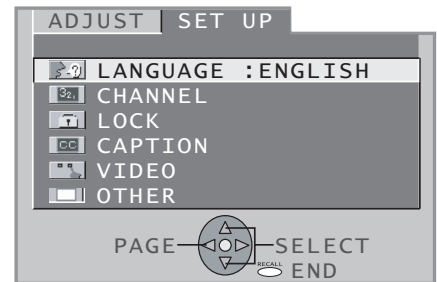
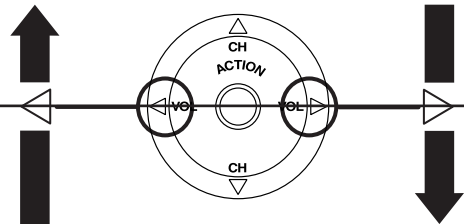
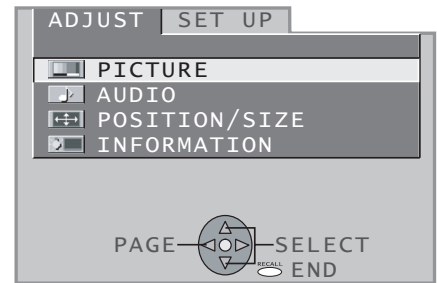
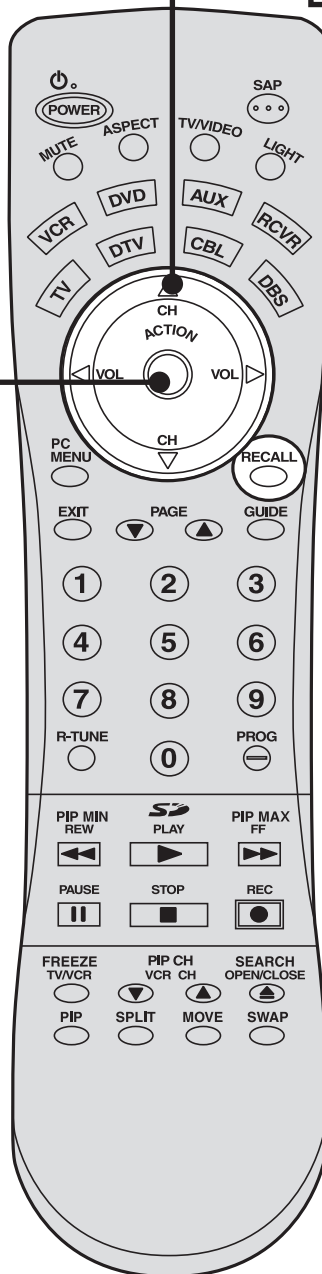
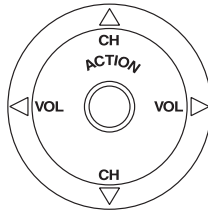

Flow Chart of Main menu

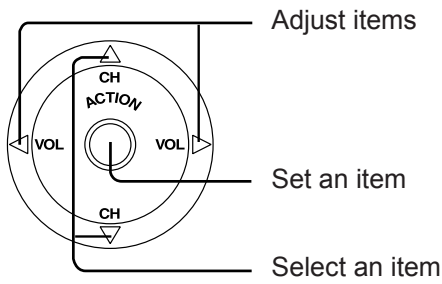

Returning to the previous screen

If RECALL is pressed while a menu screen is displayed, the display will return to the previous screen.

Note:

The display disappears if no operation is done for 5 minutes.

PICTURE ADJUST menu

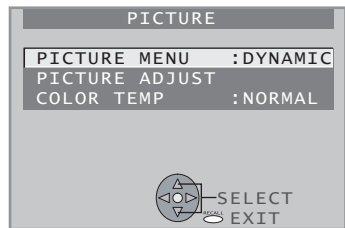

PP. 46-47

AUDIO ADJUST menu

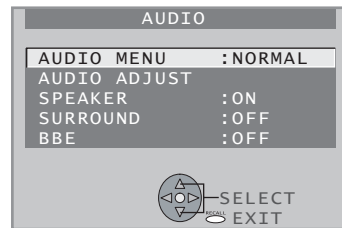

PP. 44-45

POSITION/SIZE ADJUST menu

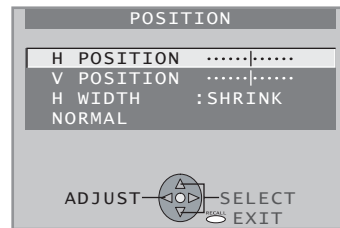

PP. 42-43

INFORMATION screen

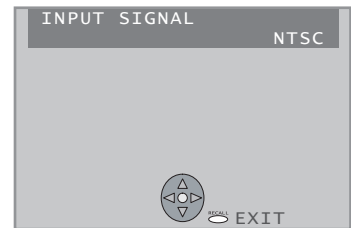

P. 61

LANGUAGE selection screen

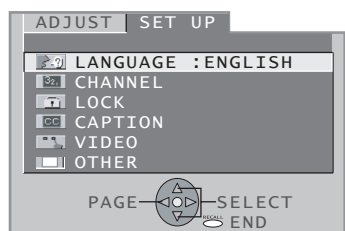

P. 61

CHANNEL menu

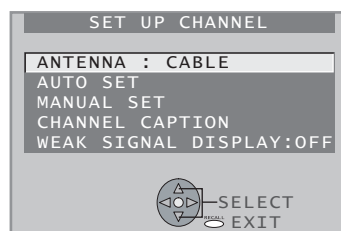

PP. 26-29, 54-55

LOCK selection screen

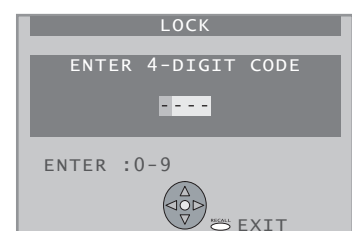

PP. 48-51

CAPTION menu

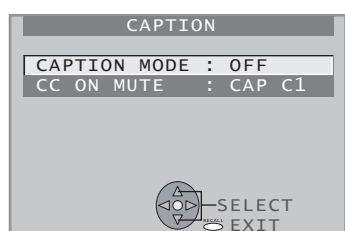

PP. 52-53

VIDEO menu

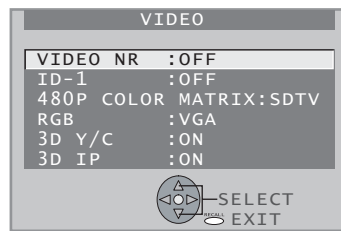

PP. 56-59

OTHER menu

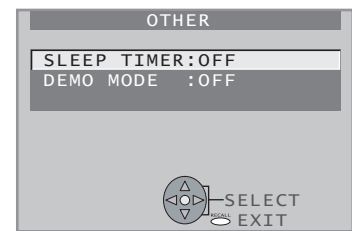

PP. 60, 62

Tuning channels

Automatic channel setting

Automatically searches and adds receivable channels to memory.



Press the ACTION button to display the MENU screen and select SET UP.

1

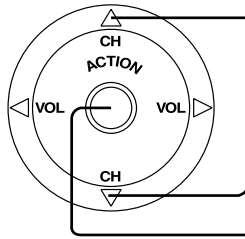

Press to select CHANNEL.

Press to display the CHANNEL.

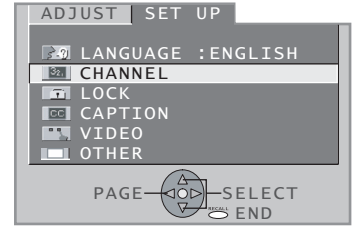

2

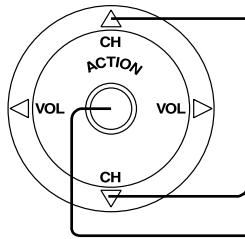

Press to select ANTENNA.

Press to select TV or CABLE.

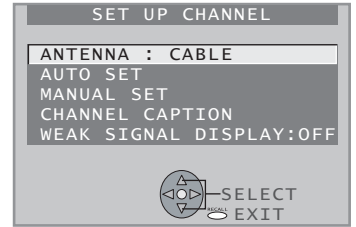

3

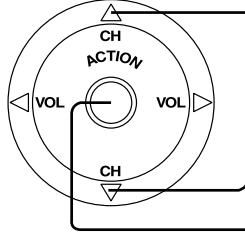

Press to select AUTO SET.

Press to run AUTO SET.

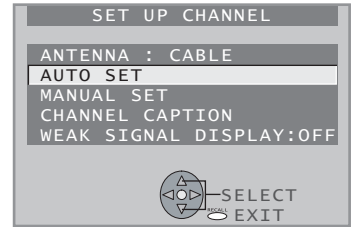

Note:

To cancel AUTO SET in progress, press the SWAP button.



Channels will automatically advance until all channels have been scanned. Channel numbers with a video signal present will be stored in the channel scan memory.

Continued on the next page.

Note:

TV or Cable Tuning mode must be set according to your connections.

4

Case 1

When setup is complete, the lowest channel picture appears.

Case 2

If setup is incomplete, the screen at right appears. Check connection of Antenna/Cable to the RF in Terminal, then try Automatic Channel Setting again.

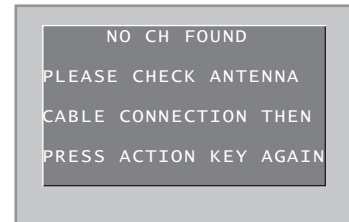

5

RECALL



Press to exit menu.

Notes:

- After AUTO SET is finished, the lowest channel number added will be received.
- Some channels with very weak signals may be locked into memory. If desired, these channels can be deleted manually using the MANUAL SET feature.

Tuning channels

Manual channel setting

Use this setting when changing setting of receiving channels or changing the channel display.

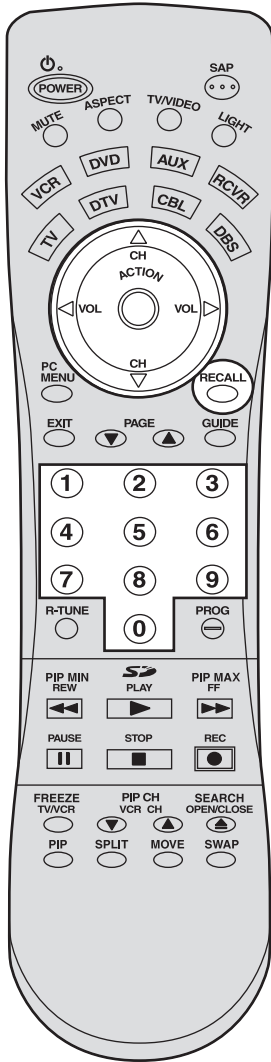

Press the ACTION button to display the MENU screen and select SET UP.

1

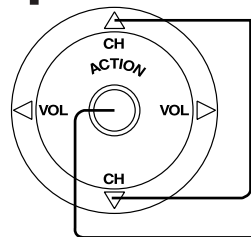

Press to select CHANNEL.

Press to display the CHANNEL.

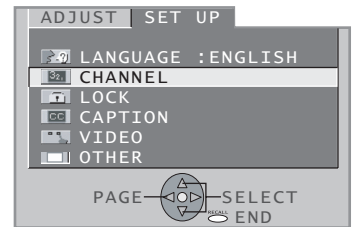

2

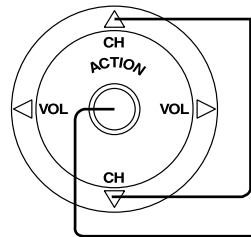

Press to select ANTENNA.

Press to select TV or CABLE.

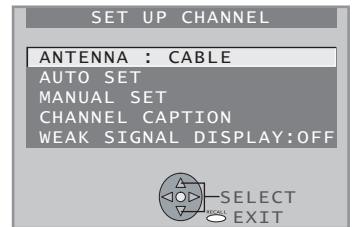

3

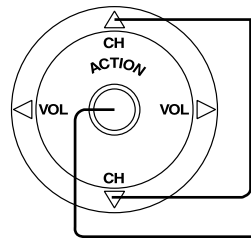

Press to select MANUAL SET.

Press to display the MANUAL SET screen.

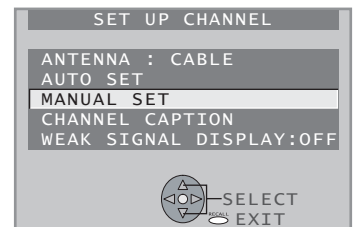

Continued on the next page.

4 To add channel

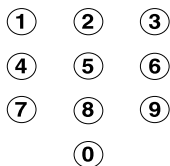

Press to select channel.

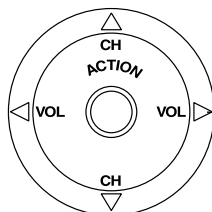
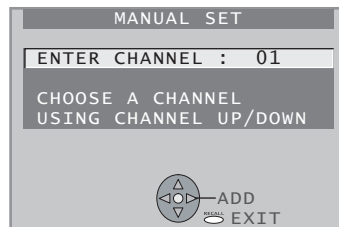

Press to add channels to memory.

To delete channel

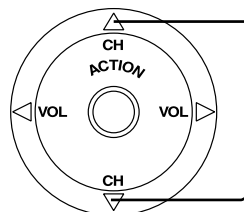

Press to select channel.

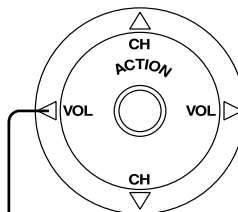
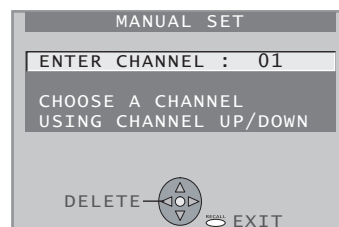

Press to delete channels from memory.

5 Repeat steps 4 to continue adding or deleting channels.

6 **RECALL**
 Press to exit menu.

Note:

Some channels with very weak signals may be locked into memory. If desired, these channels can be deleted manually using the MANUAL SET feature.

Projection display operation

Operation can be done from the projection display.

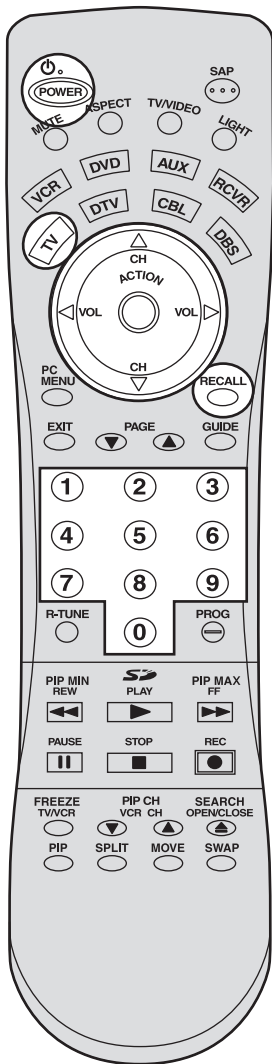
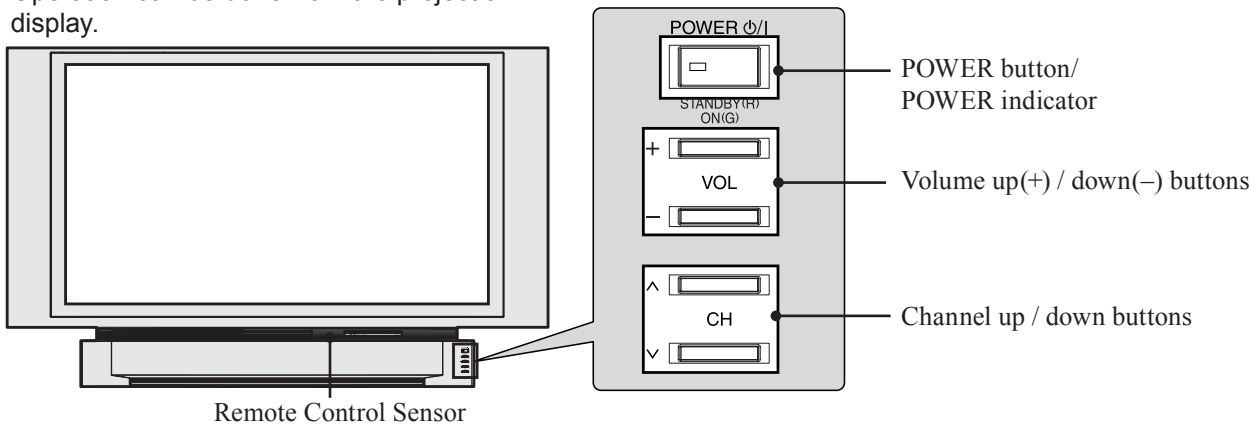

- 1 Press to operate the projection display with the remote control.
- 2 Press to turn the projection display on.
- 3 Press to select the desired channel. (Or use number keys)

CABLE 125 or TV 69

CH 01

↕

CH 02

⋮

CH 125

Or

1 2 3

4 5 6

7 8 9

0

Note:
Refer to "Using the number keys" on the next page.

- 4 Press to select the desired volume level.

- Notes:**
- The channel number and volume level are stored even after the projection display is turned off.
 - Power consumption can be reduced if the volume level is lowered.

Projection display operation

TV status display



Press the RECALL button, except when the MENU screen is displayed, to display current TV status information.

Aspect types (P. 32)
Receivable broadcast types (P. 37)

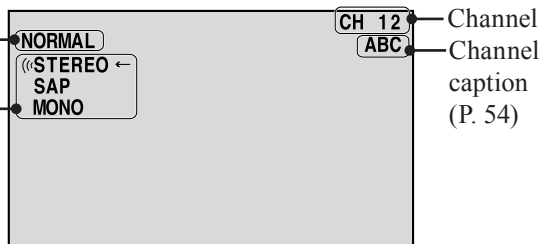

Using the number keys

- ① ② ③ When selecting CABLE channels 100 to 125 with the number keys, first press the 1 key, and then enter the remaining two digits.
- ④ ⑤ ⑥ Example 1: To select channel 125, first press the 1 key, then 2, then 5.
- ⑦ ⑧ ⑨ Example 2: To select channel 12, press the 1 key, then 2. Channel 12 appears momentarily.
- ⑩ Example 3: To select channel 8, press the 8 key. Channel 8 appears momentarily.

Using projection display Channel up/down buttons to select input mode

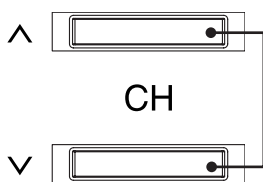

Projection display Channel up/down buttons can also be used to select an outside input as shown right.

* No input mode is displayed for terminals with no equipment connected.

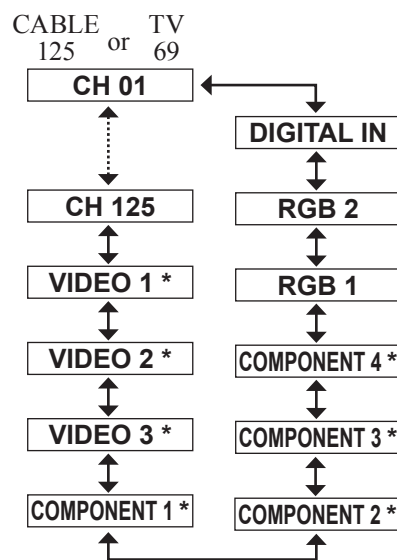

Auto shut off

To extend lamp life, if there is no signal to the set's tuner for 5 minutes, the lamp will shut off automatically.

Invalid operation notification

If an invalid operation is attempted, the mark shown right is displayed.

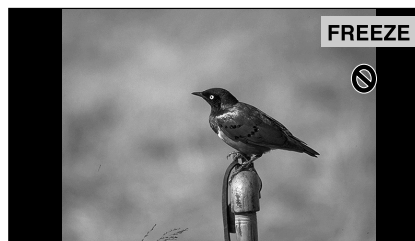

Example: Invalid operation was tried during FREEZE mode.

ASPECT Controls

The color monitor will allow you to enjoy viewing the picture at its maximum size, including wide screen cinema format picture.



ASPECT

The aspect mode changes each time the ASPECT button is pressed.

- When a 480p signal is being received, the mode switches between NORMAL, ZOOM, and FULL only.
- During PC input, the mode switches between NORMAL, FULL and TRUE only.
- When XGA and Mac 19 signal is input, the aspect will be NORMAL and FULL only.

Notes:

- When a 1080i or 720p signal is being received, the mode is set to FULL, and aspect switching is not possible.
- When input mode is CARD, the mode is set to NORMAL, and aspect switching is not possible.

Notes:

- However, if the mode selected does not match the aspect ratio of the input signal, the original picture quality may be affected.
- If using this projection display in places, such as cafes or hotels, with the aim of displaying programs for a commercial purpose or for public presentation, please note that by using the aspect ratio (16:9) selection function to change the aspect ratio, you may be infringing on the rights of the original copyright owner of that program under copyright protection laws.
- If a normal (4:3) picture is projected in wide screen, distortion may occur around the edges so that part of the picture may no longer be visible. We recommend viewing in 4:3 mode so you can enjoy the picture as it was intended to be seen.

ASPECT Controls

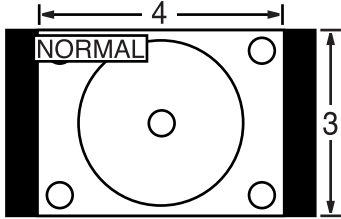
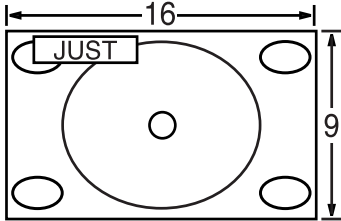
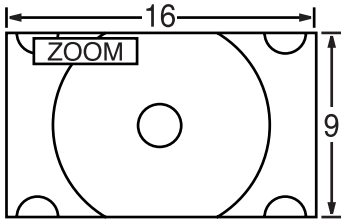
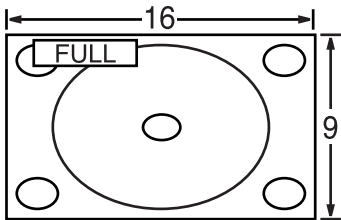
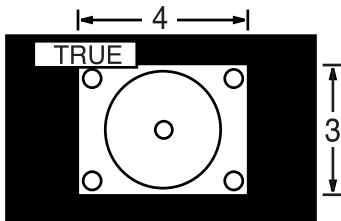
Mode	Picture	Explanation
<p>NORMAL</p>		<p>NORMAL will display a 4:3 picture at its standard 4:3 size.</p>
<p>JUST</p>		<p>JUST mode will display a 4:3 picture at maximum size but with aspect correction applied to the center of the screen so that elongation is only apparent at the left and right edges of the screen. The size of the picture will depend on the original signal.</p>
<p>ZOOM</p>		<p>ZOOM mode magnifies the central section of the picture.</p>
<p>FULL</p>		<p>FULL will display the picture at its maximum size but with slight elongation.</p>
<p>TRUE</p>		<p>You can reduce the image and adjust it to the original image quality. (Except XGA)</p>

Notes:

- The screen size changes if ID-1 is detected. (P. 57)
- When ASPECT is in ZOOM mode, PIP feature cannot be used. (P. 40)

Searching for the desired channel (Channel search)

Channel search displays each channel, in order, as a paused image. Channels are displayed from the left top to the right bottom in order. When it reaches the right bottom, the next channel is displayed at the left top, overwriting the previously displayed channel.

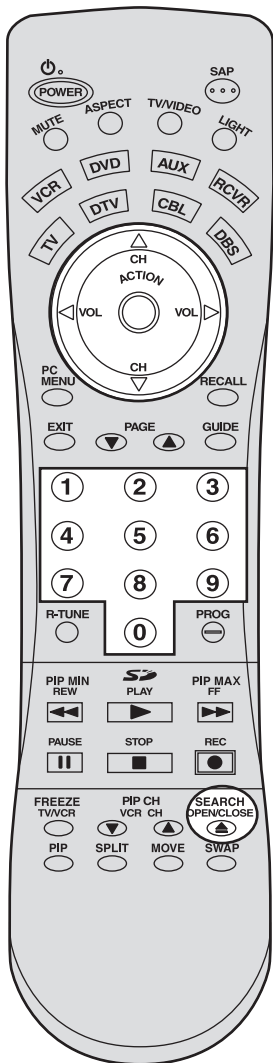

**SEARCH
OPEN/CLOSE**



When the SEARCH/OPEN/CLOSE button is pressed during single screen.

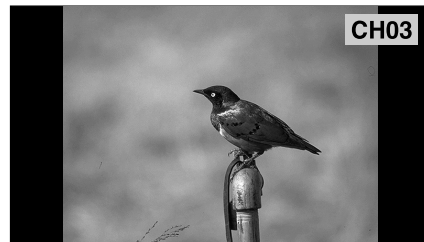

Example 1

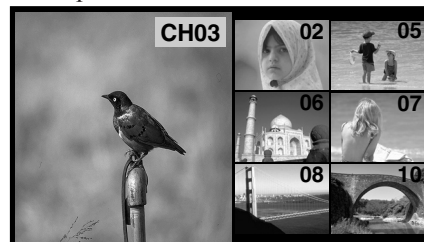

Example 2 (RGB input)



When a channel button is pressed during channel search.

Number keys:

Example: When 6 is pressed, channel 6 is displayed in single screen.

Channel up and down buttons:

When ▲ or ▼ button is pressed, the next channel up or down is displayed in single screen.

Example: Select channel 6

Sound from the left screen is output from the speakers on the projection display set.

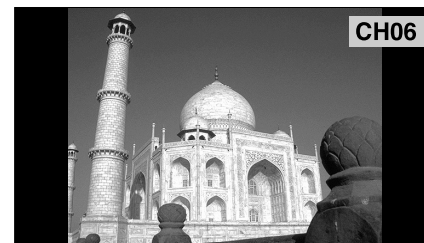

Notes:

- To end channel search, press SEARCH/OPEN/CLOSE.
- While using the PIP feature, Channel search is not available.

Playing peripheral equipment

Confirming connections

A video camera uses the Input 3 terminal on the front of the projection display.

Example: Connect Input 3

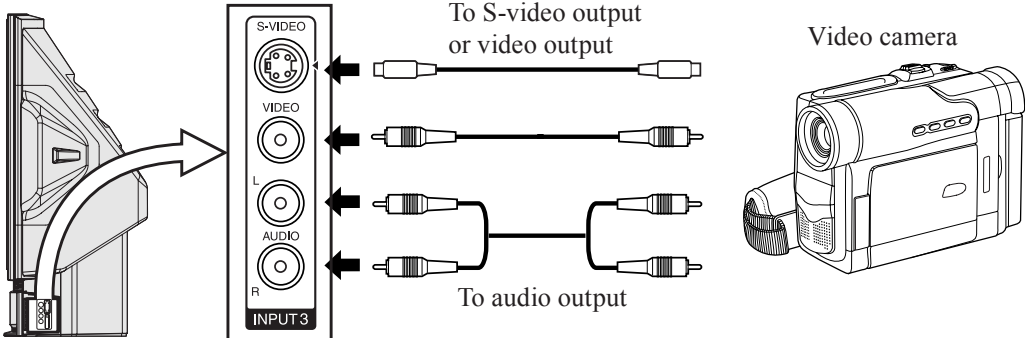

VCR

DVD player

This equipment can also be connected to the rear terminals. See Connections for details.



Turning the power on and switching input modes

- 1 Turn the projection display on.
- 2 The input mode changes each time this button is pressed.
 - * No input mode is displayed for terminals with no equipment connected.
 - Card input mode is selected.
 - RGB input mode is selected.

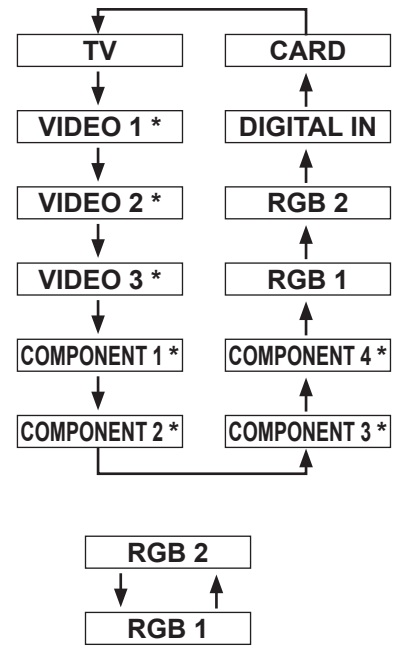

VIDEO 1	Signal of source connected to INPUT 1 is displayed.
VIDEO 2	Signal of source connected to INPUT 2 is displayed.
VIDEO 3	Signal of source connected to INPUT 3 is displayed.
COMPONENT 1	Signal of source connected to COMPONENT VIDEO INPUT 1 is displayed.
COMPONENT 2	Signal of source connected to COMPONENT VIDEO INPUT 2 is displayed.
COMPONENT 3	Signal of source connected to COMPONENT VIDEO INPUT 3 is displayed.
COMPONENT 4	Signal of source connected to COMPONENT VIDEO INPUT 4 is displayed.
RGB 1	Signal of source connected to RGB IN 1 is displayed.
RGB 2	Signal of source connected to RGB IN 2 is displayed.
DIGITAL IN	Signal of source connected to DIGITAL IN is displayed.
CARD	Signal of source connected to CARD SLOT is displayed.

- 3 Operate the connected equipment.

Mute / Freeze / SAP



Sound mute



Useful when answering the phone or receiving unexpected visitors

Press this button to mute the sound. Press again to reactivate sound. Sound is also reactivated when power is turned off or volume level is changed.



Note:

The audio output from AV OUT is not muted.

Freezing pictures



Projection can be switched between a frozen (still) picture and a moving picture each time the FREEZE button on the remote control unit is pressed. Press FREEZE button again to resume motion.



Note:

The video output from AV OUT is not frozen.

Receivable Broadcast Types

The following are possible broadcast types with their accompanying on-screen displays. The signal being received is indicated with a “⌂” mark while the selected audio mode is indicated with an arrow. To change the audio mode for these broadcasts, follow the “Select Audio Mode for TV Viewing” section (below.)

MTS Stereo and SAP broadcast

Multi-channel Television Sound Stereo (main language) and Secondary Audio Program (sub language) broadcasts are both being received simultaneously. Select the STEREO or SAP audio mode.



MTS Stereo broadcast

Multi-channel Television Sound Stereo broadcast. Select STEREO audio mode.

- If stereo broadcast is weak and the display flickers, select MONO audio mode for possibly better results.

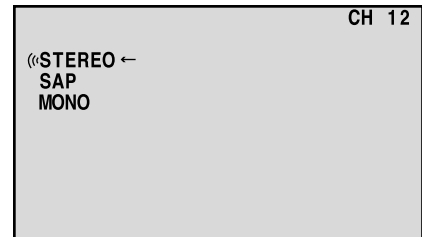

SAP broadcast

Secondary Audio Program (sub language).
Select SAP audio mode for the sub language.



MONO broadcast

Normal monaural sound broadcast.



Select Audio Mode for TV Viewing



Press SAP button to select the desired audio mode as described below.
(Arrow shows selection.)

- Each press of SAP button will change the audio mode as shown below.
- “SAP” is selected with first press of SAP button.

Example:

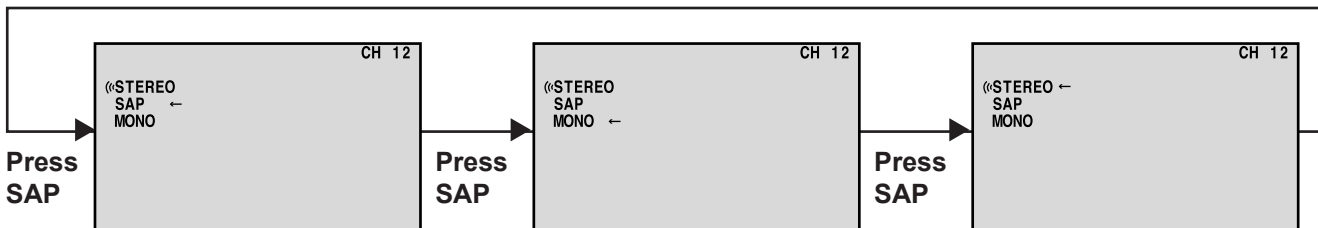

Split screen



Notes:

- Sound from the Left screen is output from the speakers on the projection display set.
- When the screen is split, signals of the Left screen are output from the rear monitor output terminal.
- The left and right screens are processed by individual circuits and, therefore, may vary in image quality.
- Split screen returns to single screen when the projection display is turned off.
- With the Left screen, as with a single screen, you can change the input, change channels, and adjust the volume.
- The right and left screens cannot display the same picture at the same time.
- A split screen which includes an RGB/DIGITAL IN signal is fixed as SPLIT SCREEN NORMAL. (Example: RGB input is shown right.)
- CARD input screen cannot be displayed using the Split Screen function.

Splitting the screen

SPLIT



Press to split.

(The previously selected screen appears on the left.)

Left screen
(Main picture)

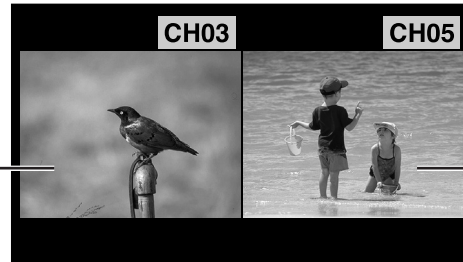

Right screen
(Sub picture)

- Returning to one screen.

SPLIT



Press to return.

Selecting the screen aspect for split screen.

ASPECT



Press to select modes.

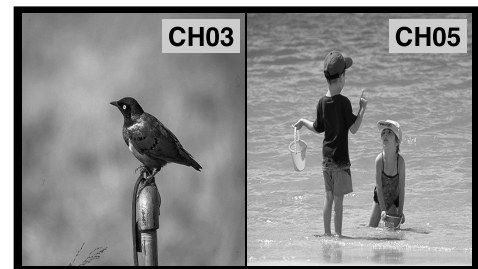

SPLIT SCREEN FULL

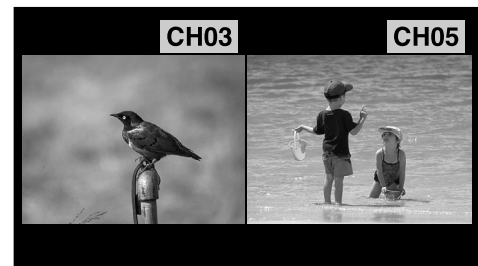

SPLIT SCREEN NORMAL



SPLIT SCREEN NORMAL
(Example: RGB input)

Changing the channel of the right screen

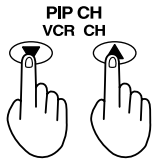

Press to select the desired channel.

Example:
During SPLIT SCREEN NORMAL

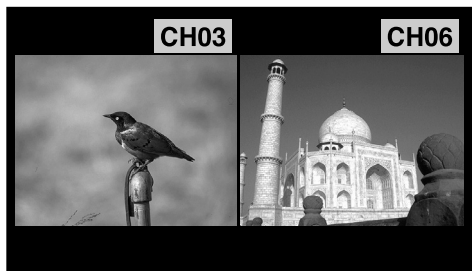
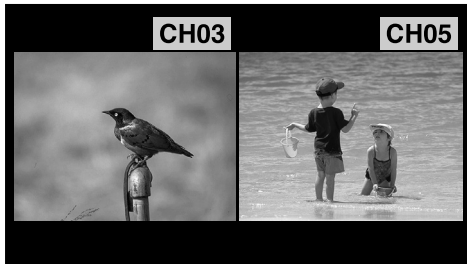

PIP ▲, ▼ buttons can also be used to select an outside input for the right side of the screen.

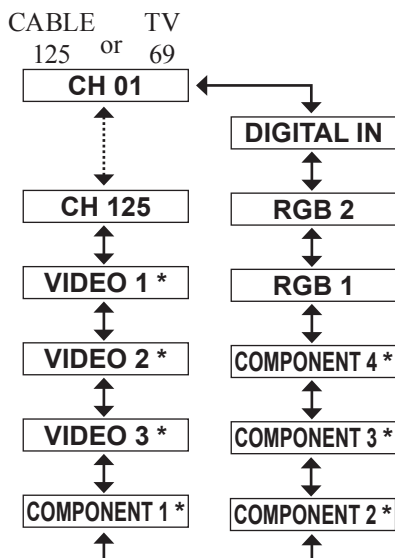

* No input mode is displayed for terminals with no equipment connected.

Note:
When outside input is finished, the lowest registered channel number is displayed. For faster selection, press the SWAP button to change the screen to the left. Then, press the TV/VIDEO button to directly change the input. Finally, press SWAP button again to change the screen back to the right.

Swapping left and right screens



Press to swap.

Example:
During SPLIT SCREEN NORMAL

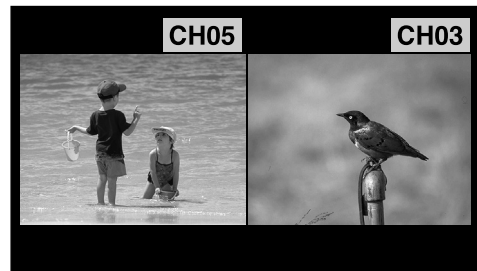
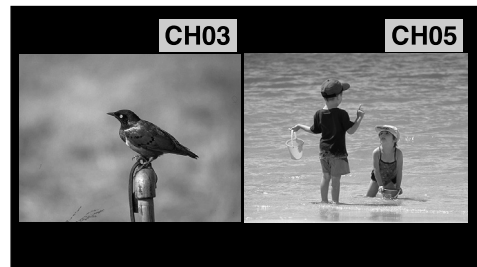

Example:
During SPLIT SCREEN NORMAL
(RGB input)

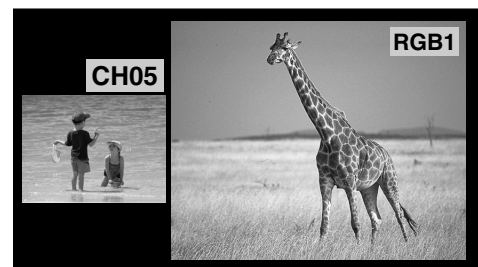

Note:
Picture quality may change according to the combination of signals input to the left and right screens.

Picture in Picture (PIP) Screen

You can view two pictures simultaneously using two tuners and picture in picture (PIP) display function.



Display PIP screen



Press to split
(The previously selected screen appears on the Main.)

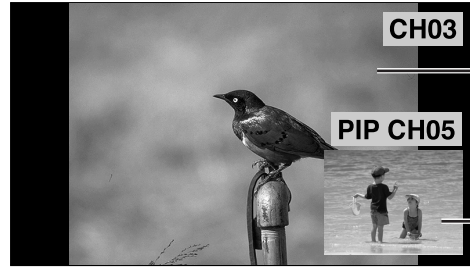

- Returning to one screen.



Press to return.

Notes:

- Sound from the Main screen is output from the speakers on the projection display set.
- In PIP mode, the Main screen signal is output from the rear monitor output terminal.
- Because Main and PIP screens are processed by individual circuits, image quality may vary slightly.
- PIP mode returns to single screen when the projection display is turned off.
- The Main and PIP screens cannot display the same picture at the same time.
- An RGB/DIGITAL IN signal and CARD input screen cannot be displayed using the PIP screen function.
- A component signal cannot be displayed on a PIP screen. Thus, when a component signal is displayed on the Main screen, the SWAP button becomes invalid.
- With the Main screen, as with a single screen, you can change the input, change channels, and adjust the volume.
- When ASPECT is in ZOOM mode, PIP feature cannot be used. (P. 32)

Picture in Picture (PIP) Screen

Changing the channel of the PIP screen

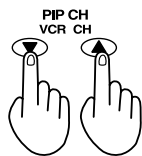

Press to select the desired channel.

Example:
During Main screen NORMAL

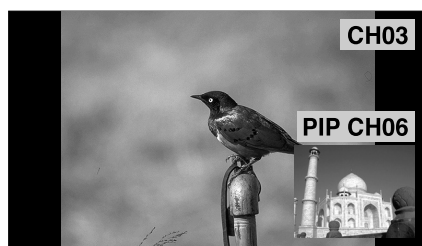
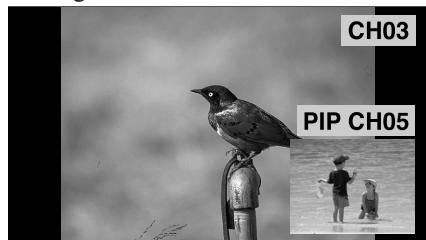

Note:

PIP ▲, ▼ buttons can also be used to select an outside input for the PIP screen.

Swapping Main and PIP screens



Press to swap.

Example:
During Main screen NORMAL

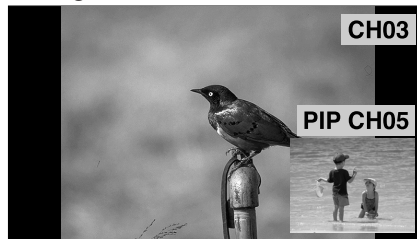

Selecting the screen size for PIP screen

You can choose PIP screen size of 3 magnifications.



Press to large PIP screen size. → ①



Press to small PIP screen size. → ②

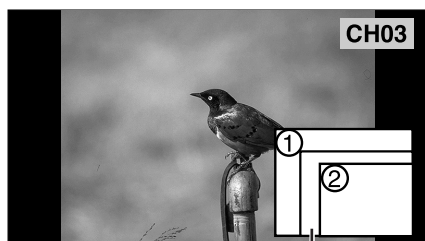

Initial size

Note:

The last size chosen is saved and will not be erased even if the power is turned off.

Move PIP screen

You can move the PIP screen to four positions.



Press repeatedly to select PIP position.

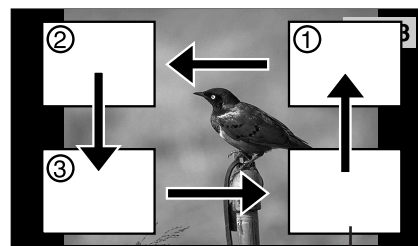
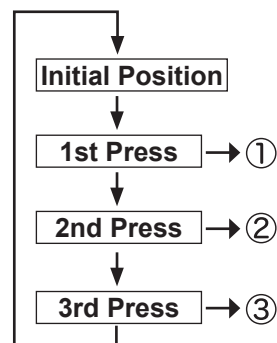

Initial position

Note:

The last position chosen is saved and will not be erased even if the power is turned off.

Adjusting screen position and size



1 **ASPECT**

Press to select the screen mode.

2 Press the ACTION button to display the MENU screen and select ADJUST.

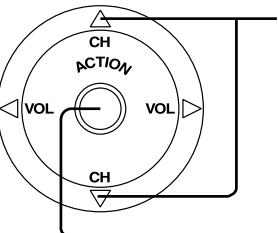

Press to select POSITION/SIZE.

Press to display POSITION/SIZE.

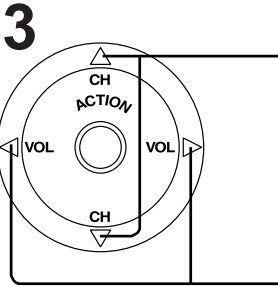
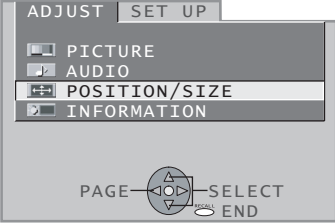

Press to select the menu to set each item.

Press to adjust POSITION/SIZE.

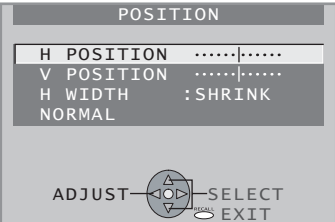

JUST mode

NORMAL is displayed at default.

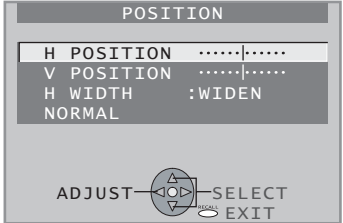

NORMAL mode

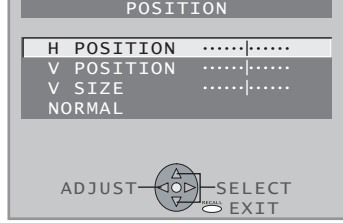

ZOOM mode

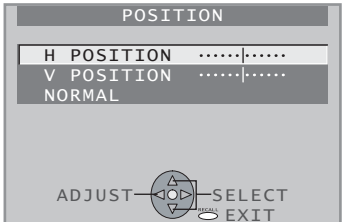

FULL mode

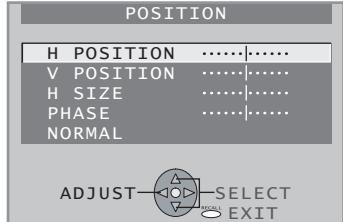

RGB input
 (DIGITAL IN: H POSITION/
 V POSITION only)

4 **RECALL**

Press to exit menu.

Adjusting screen position and size

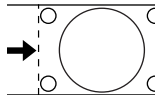
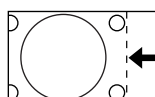
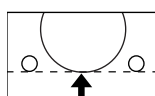
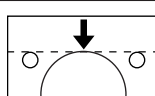
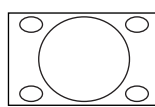
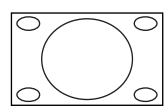
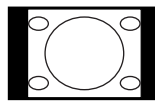
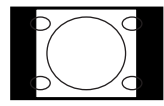
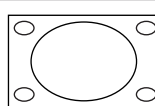
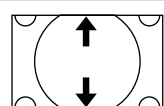
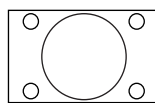
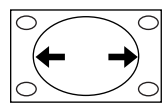
Adjustment item	Button	Adjustment Details	Note	
H Position	Press ► button.	The image moves to the right.		
	Press ◀ button.	The image moves to the left.		
V Position	Press ► button.	The image moves up.		
	Press ◀ button.	The image moves down.		
H WIDTH	Press ACTION button.	If noise appears on the ends of the image in SHRINK, switch to ENLARGE.	 (SHRINK)  (ENLARGE)	Only JUST mode
		If noise appears on the ends of the image in WIDEN, switch to NARROW.	 (WIDEN)  (NARROW)	Only NORMAL mode (Except PC input)
V SIZE	Press ► button.	Press to enlarge image vertically		Only ZOOM mode
	Press ◀ button.	Press to shrink image vertically		
H SIZE	Press ► button.	Press to enlarge image horizontally		RGB input
	Press ◀ button.	Press to shrink image horizontally		
PHASE	Press ► button. Press ◀ button.	Adjust in order to remove any picture interference or contour blurring which may occur in computer images.		RGB input

Notes:

- This projection display is equipped with various screen modes. If a screen mode with a different aspect from the broadcast program is selected, image will appear differently. Select the proper screen mode with this in mind.
- Be careful when using this projection display for commercial purposes or for public use, such as in cafes and hotels.
- Shrinking and enlarging images by using screen mode switching function (zoom, etc.) may violate copyright laws.
- Images displayed on a wide screen TV will be cut off or distorted at the edges, when viewing normal aspect images of 4:3 in ZOOM, JUST or FULL mode. Display in NORMAL mode to view the original image intended by the producer.
- For 1080i and 720p input images, screen size cannot be adjusted.
- The adjusted setting will be kept even when the projection display is turned off.
- The signals output from the monitor output terminal on the back of the projection display is not affected when the screen size and position is adjusted.

Audio Adjustments

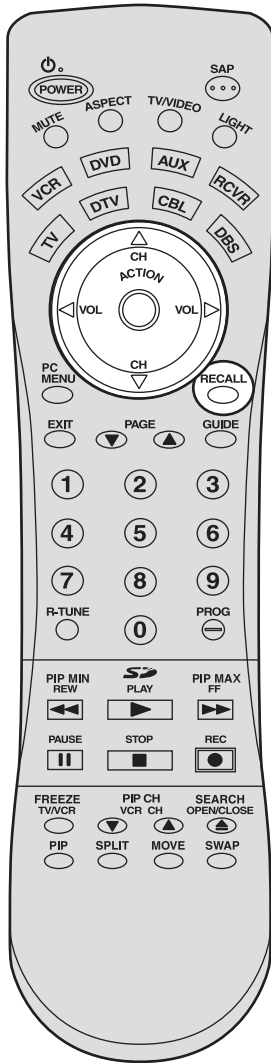

Press the ACTION button to display the MENU screen and select ADJUST.

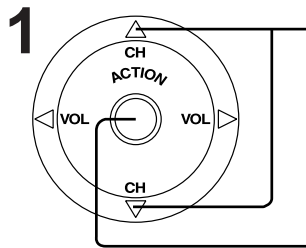

Press to select AUDIO.

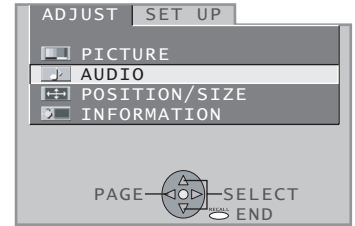

Press to display AUDIO screen.

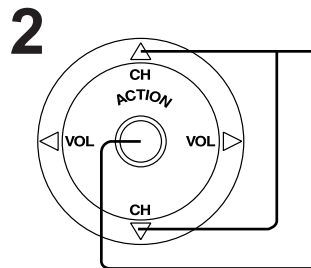

Press to select the menu to set each item.

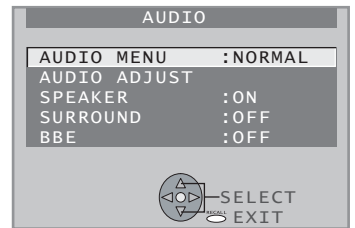

Press to set each item.

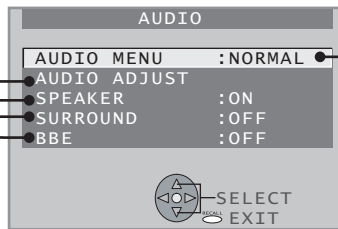

See next page

You can hear deeper, 3D audio using just the units two front speakers. Surround sound effect is not available for normal (mono) broadcasts.

You can turn off the internal speakers when it is connected to external audio equipment.

See next page

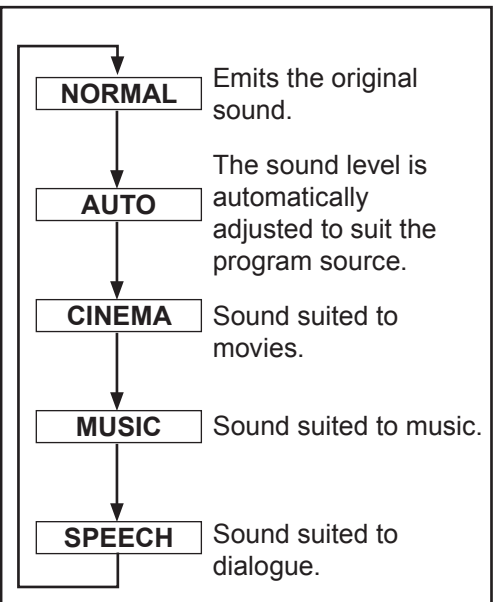

Press to exit menu.

Notes:

- Sound signals are output from the rear AUDIO OUT terminal.
- When volume is adjusted or the mute button is pressed from the remote control, a message will be displayed.

Audio Adjustments

1 Repeat step 1 on page 44.

2 Press to select AUDIO ADJUST.

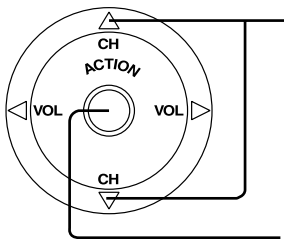

Press to display AUDIO ADJUST screen.

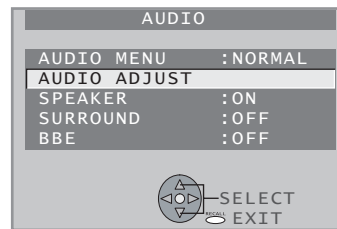

3 Press to select the menu to set each item.

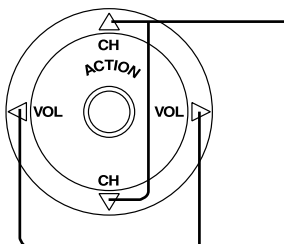

Adjust the desired level by listening to the sound.

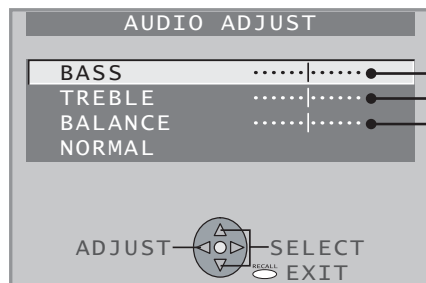
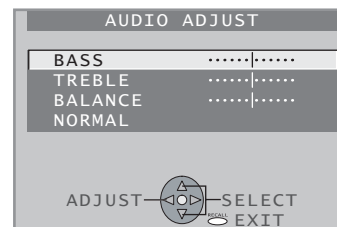

BASS
Adjusts low sounds

TREBLE
Adjusts high sounds

BALANCE
Adjusts left and right volumes

NORMAL is displayed at default.

4 Press to exit menu.



Using BBE

BBE sound technology enhances speech intelligibility and restores the dynamic range of musical passages to provide outstanding natural sound.

Note:
If BBE is ON, SURROUND cannot be selected.

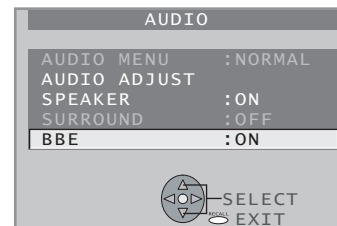

Note:
If the AUDIO MENU is set to AUTO, or if BBE is ON, BASS and TREBLE cannot be adjusted.

Picture Adjustments

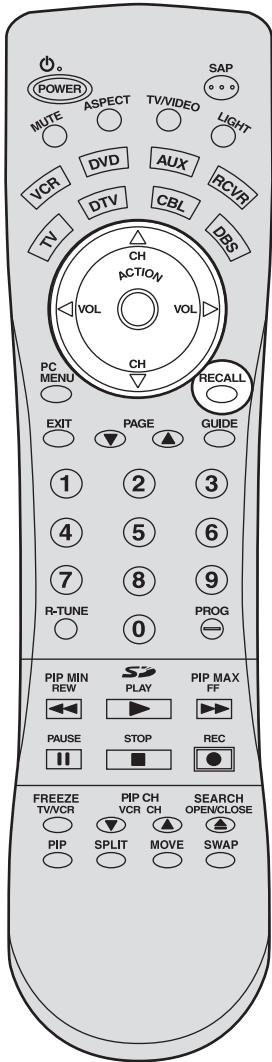

Press the ACTION button to display the MENU screen and select ADJUST.

1

Press to select PICTURE.

Press to display PICTURE screen.

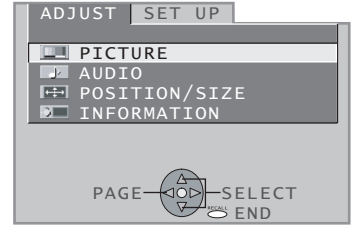

2

Press to select the menu to set each item.

Press to set each item.

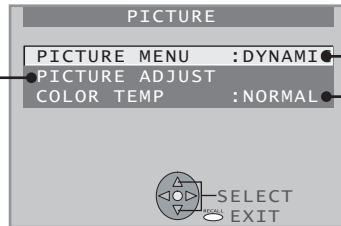
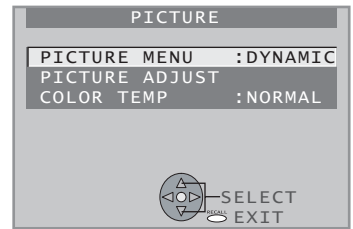

DYNAMIC Displays a clear screen with a high contrast of light to dark.

CINEMA Ideal for movies in low lighting conditions.

NORMAL Displays unaltered image.

During RGB/DIGITAL IN input, picture menu changes to NORMAL.

See next page

NORMAL Normal color

WARM Warm color (more red)

COOL Cool color (more blue)

During RGB/DIGITAL IN input, COLOR TEMP changes to NORMAL.

Note:

There is little change when PICTURE is increased with a bright picture or reduced with a dark picture.

3

RECALL Press to exit menu.

Picture Adjustments

1 Repeat step 1 on page 46.

2  Press to select PICTURE ADJUST.

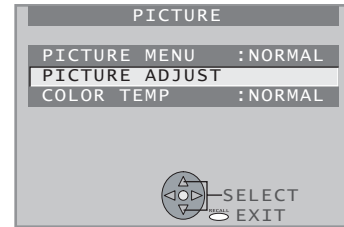

Press to display PICTURE ADJUST screen.

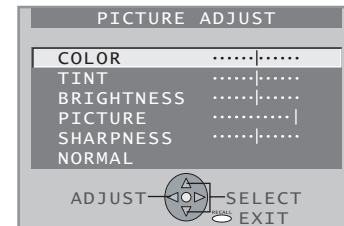

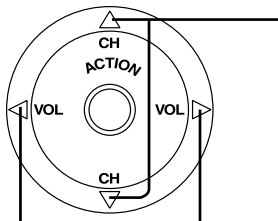
3  Press to select the menu to set each item.

Adjust to desired level while viewing picture through the menu overlay.

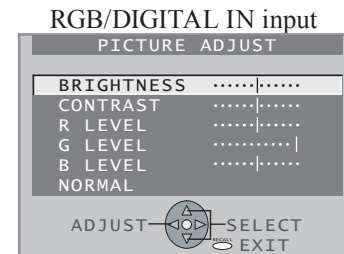

NORMAL returns all items to factory defaults. Also, returns COLOR TEMP (p. 46) to NORMAL.

4  Press to exit menu.

COLOR

Adjustment item	Button	Adjustment Details	Remarks
COLOR	Press ► button.	The color becomes deeper.	Except RGB/DIGITAL IN
	Press ◀ button.	The color becomes paler.	
TINT	Press ► button.	Flesh tones become greenish.	Except RGB/DIGITAL IN
	Press ◀ button.	Flesh tones become reddish.	
BRIGHTNESS	Press ► button.	The screen becomes brighter.	
	Press ◀ button.	The screen becomes darker.	
PICTURE	Press ► button.	Picture intensity becomes stronger as both contrast and color levels are adjusted.	Except RGB/DIGITAL IN
	Press ◀ button.	Picture intensity becomes weaker as both contrast and color levels are adjusted.	
SHARPNESS	Press ► button.	The picture quality becomes sharper.	Except RGB/DIGITAL IN
	Press ◀ button.	The picture quality becomes softer.	
CONTRAST	Press ► button.	Only the Highlights of the image become brighter, adding Contrast.	RGB/DIGITAL IN only
	Press ◀ button.	The Highlights become less bright, diminishing Contrast.	
R LEVEL	Press ► button.	The red component becomes stronger.	RGB/DIGITAL IN only
	Press ◀ button.	The red component becomes weaker.	
G LEVEL	Press ► button.	The green component becomes stronger.	
	Press ◀ button.	The green component becomes weaker.	
B LEVEL	Press ► button.	The blue component becomes stronger.	
	Press ◀ button.	The blue component becomes weaker.	

Lock Feature

This projection display has a built-in V-Chip Control which allows you to block unwanted TV usage based on US MOVIES and US TV PROGRAMS ratings.

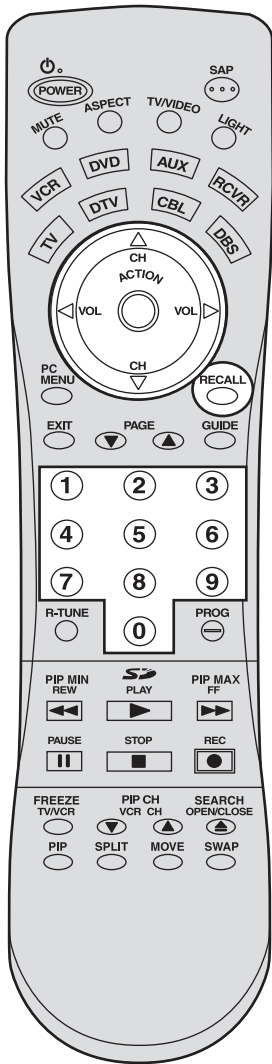

Enter Secret Code

A 4-digit code must be entered to view a blocked program or change rating settings.

Press the ACTION button to display the MENU screen and select SET UP.

1

Press to select LOCK.

Press to display the LOCK screen.

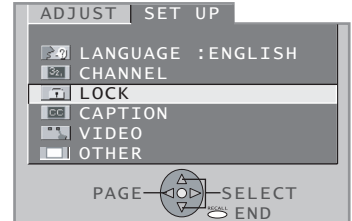

2

Press number keys to enter your secret code.



+

Press to save 4-digit code.



Changing your secret code

- You will need your current code. Press "◀" to clear current code. Repeat step 2 to enter new code.

Note:

- Use a code that is easy to remember and record it in a safe place.

3

Press to exit menu.

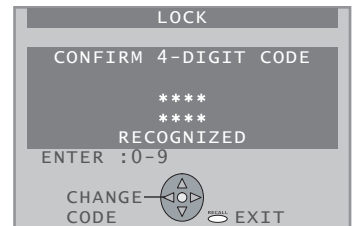

Or,

Press to display LOCK menu for rating screen and go to page 49 (US MOVIES Ratings), or page 50 (US TV PROGRAMS Ratings).

Notes:

- Once ratings are set, restricted tapes or programs cannot be accessed unless the secret code is entered.
- If you forget your secret code, refer to "Reset User's Memory Functions" on page 51.

Setup US MOVIES Ratings

Perform "Enter Secret Code" step 1 on page 48.

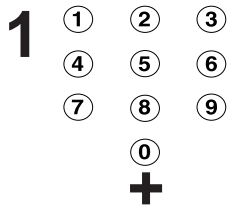

Press number keys to enter your secret code.

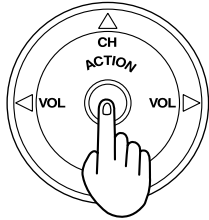

Press to set.

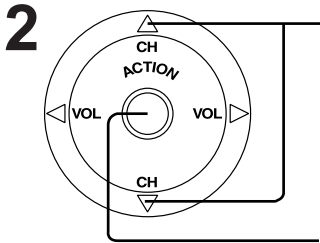

Press to select US MOVIES.

ON: V-Chip Control is activated.
OFF: V-Chip Control is deactivated.

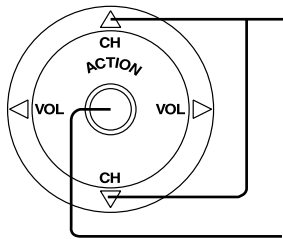
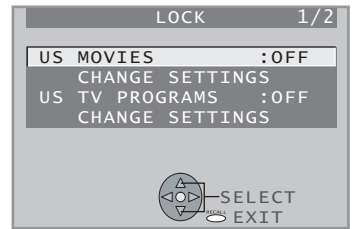

Press to select CHANGE SETTINGS.

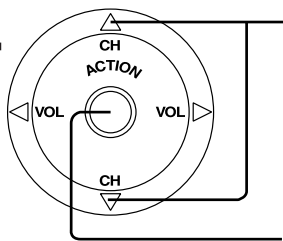
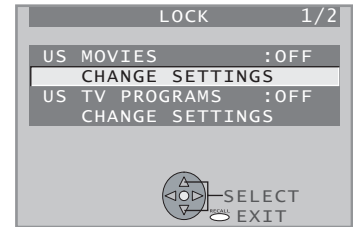

Press to select VIEW NR PROGRAMS?.

VIEW NR (Not Rated) PROGRAMS
NO: Cannot view NR programs.
YES: Can view NR programs.

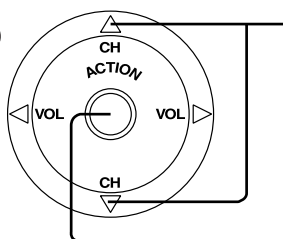
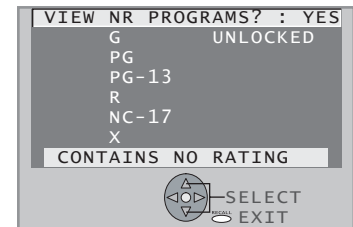

Press to select ratings to be blocked. (P. 51.)

Note:
Ratings highlighted in Red will be blocked while those not highlighted (black letters) will not be blocked.

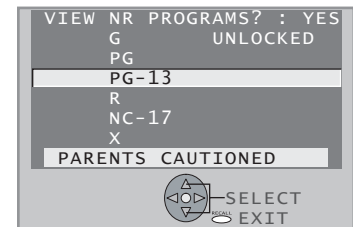

Press to exit menu.

Lock Feature

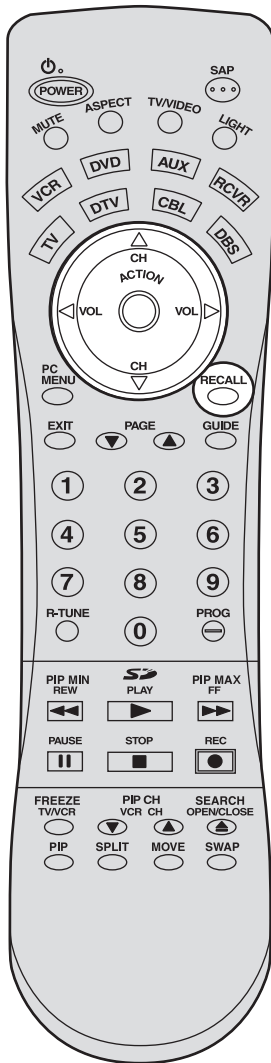

Setup US TV PROGRAMS Ratings

Perform "US MOVIES Ratings" step 1 on page 49.

1  Press to select US TV PROGRAMS.

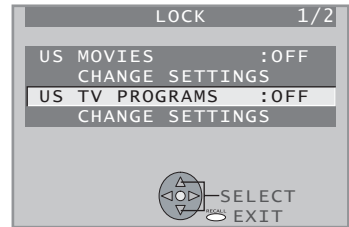

Press to set.

ON: V-Chip Control is activated.
OFF: V-Chip Control is deactivated.

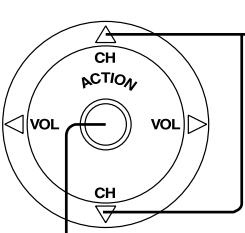
2  Press to select CHANGE SETTINGS.



Press to display the CHANGE SETTINGS screen.

3  Press to select VIEW NR PROGRAMS?.

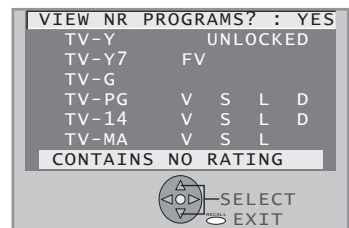

Press to set "YES" or "NO".

VIEW NR (Not Rated) PROGRAMS
NO: Cannot view NR programs.
YES: Can view NR programs.

4  Press to select ratings to be blocked. (P. 51.)

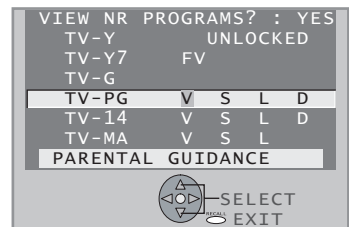

Press to set.

You may select from standard TV ratings (chart 1), or customize to a specific content rating (chart 2.)

Note:

Ratings highlighted in Red will be blocked while those not highlighted (black letters) will not be blocked.

5  Press to exit menu.

US MOVIES RATINGS:

G	GENERAL AUDIENCE: All ages admitted.
PG	PARENTAL GUIDANCE SUGGESTED: Some materials may not be suitable for children.
PG-13	PARENTS CAUTIONED: Some materials may be inappropriate for children under 13.
R	RESTRICTED Children under 17 must be accompanied by a parent or adult.
NC-17	OVER AGE 17 ONLY: No one 17 and under admitted
X	ADULTS ONLY:

US TV PROGRAMS RATINGS: Chart 1

TV-Y	FOR ALL CHILDREN: Content specifically geared to young viewers ages 2-6.
TV-Y7	FOR AGE 7 AND OLDER: May contain mild physical or comedic violence which may frighten children under 7.
TV-G	GENERAL AUDIENCE: Contains little or no violence, strong language, or sexual dialogue or situations.
TV-PG	PARENTAL GUIDANCE: May contain infrequent coarse language, limited violence, some suggestive sexual dialogue and situations.
TV-14	PARENTS CAUTIONED: May contain sophisticated themes, sexual situations, strong language, and more intense violence.
TV-MA	MATURE AUDIENCE: May contain mature themes, profane language, graphic violence, and sexual situations.

US TV PROGRAMS RATINGS: Chart 2

FV	Fantasy Violence
V	Violence
S	Sexual Situations
L	Adult Language
D	Sexually Suggestive Dialogue

Blocking Message

<When V-Chip Control is activated>

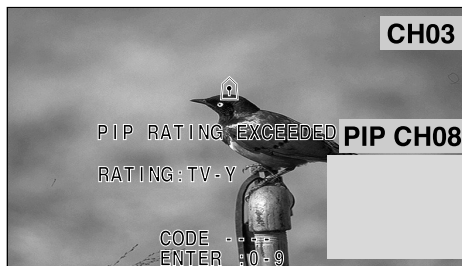
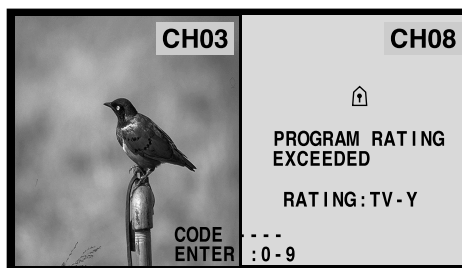
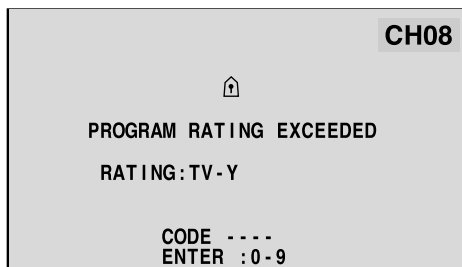

Temporarily deactivate V-Chip control

Enter your secret code in the blocking message screen.

- V-Chip control is reactivated when power is turned off or power failure occurs.

Reset User's Memory Functions

Use when moving unit to a new location, or if the secret code is forgotten.

While the OSD at right is displayed, press the VOL- button on the projection display and ACTION button on the Remote control at same time for more than 5 seconds. When reset is finished, power shuts off automatically.

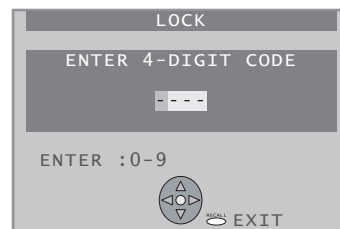

Closed Captions

This receiver has a built in decoder that provides a visual depiction of the audio portion of a television program in the form of written words across the screen (white or colored letters on a black background). It allows the viewer to read the dialogue of a television program or other information.

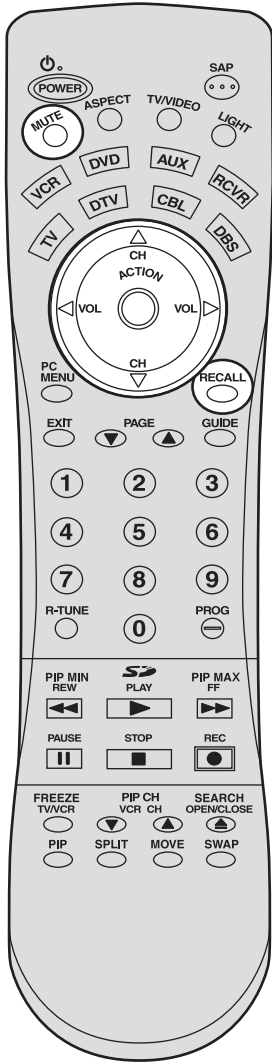

Note:

The closed caption or text signal may be broadcast over C1, C2, or both. Also, text contents can vary so you may wish to try different settings.

CAPTION MODE

Activates the On-Screen Closed Caption feature. When activated this feature will remain on until OFF is selected in this menu.

Press the ACTION button to display the MENU screen and select SET UP.

1

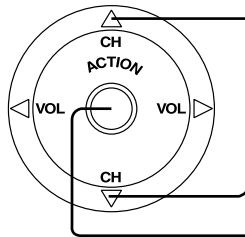

Press to select CAPTION.

Press to display the CAPTION screen.

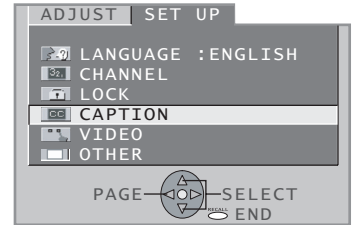

2

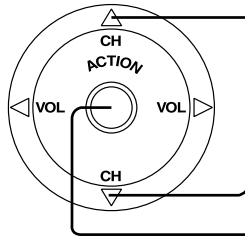

Press to select CAPTION MODE.

Press repeatedly to select CAPTION MODE.

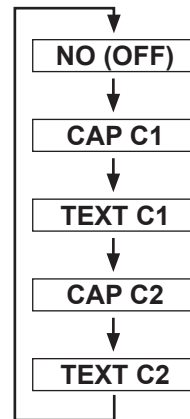
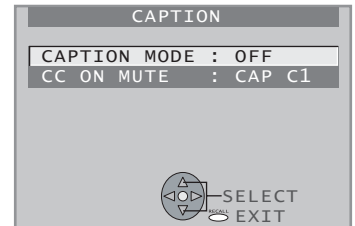

Closed Caption Modes from which to Choose

Caption Mode: CAP C1 or C2

A narration of selected TV programs is displayed. Check TV program listings for C. C. (Closed Caption) broadcasts.

Caption Mode: TEXT C1 or C2

The lower half of the screen will be blocked out. When the TV station broadcasts information, such as program listings, it will appear in this space.

Caption Mode: OFF

Closed Caption /Text narration will not be displayed.

3

RECALL



Press to exit menu.

CC ON MUTE

Activates the On-Screen Closed Caption feature, when the MUTE button on the Remote Control is pressed. To deactivate, press the MUTE button again.

Note:

This feature functions when the Closed Caption Mode is in the "OFF" position. The program being viewed must be broadcast with Closed Caption.

Press the ACTION button to display the MENU screen and select SET UP.

1 Press to select CAPTION.

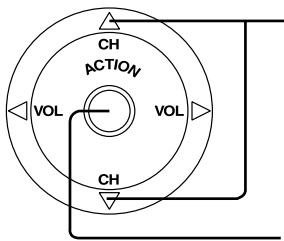

Press to display the CAPTION screen.

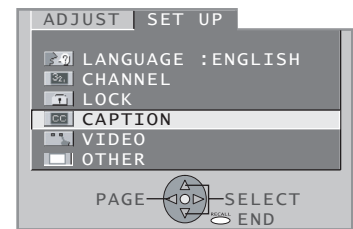

2 Press to select CC ON MUTE.

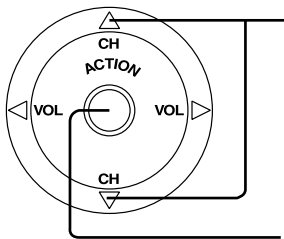

Press repeatedly to select CC ON MUTE.

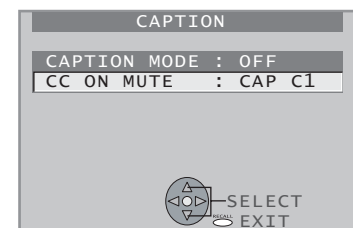

Press repeatedly to select CC ON MUTE.

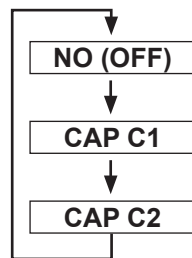

3 Press to exit menu.



Notes:

- The setting for CC ON MUTE is valid only when the CC MODE is OFF, CC MODE set to ON will override CC ON MUTE.
- Closed Caption is not displayed if the input signal is COMPONENT VIDEO INPUT of 480P or more, or from RGB/DIGITAL IN.

Channel Caption Feature

Station names, e.g. ABC, TNN, etc. so that they will appear when a channel is selected. Choose 24 preset names.

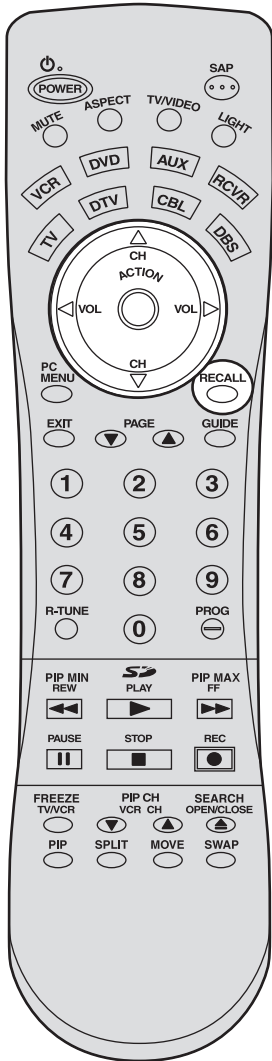

Press the ACTION button to display the MENU screen and select SET UP.

1 Press to select CHANNEL.

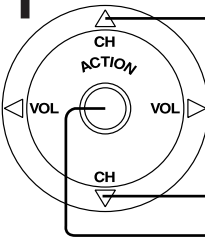

Press to display the SET UP CHANNEL screen.

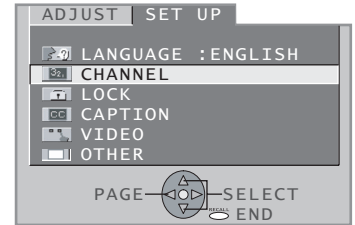

2 Press to select CHANNEL CAPTION.

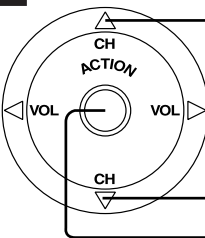

Press to display the CHANNEL CAPTION screen.

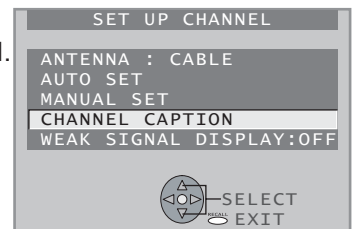

3 Press to select a station.

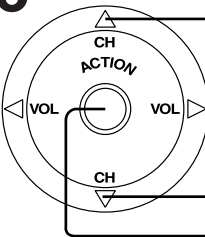

Press to move cursor to the right.

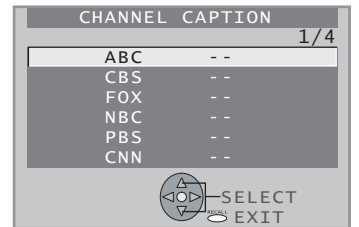

To remove a registered channel number, select the station, then press the ◀ button (CLEAR).

4 Press to select channel number.

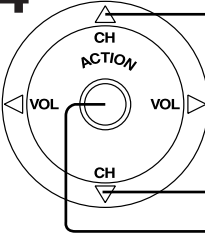

Press to set.

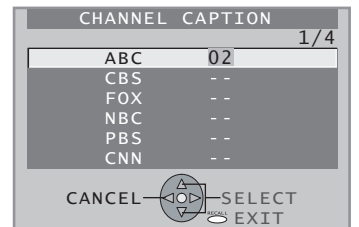

To make a correction, press the ◀ button.

- Repeat step 3 and 4 until the Caption List is complete.

5 **RECALL** Press to exit menu.



Weak Signal Display Feature

When "ON" is selected, the picture is displayed even when a broadcast signal is weak or non-existent.

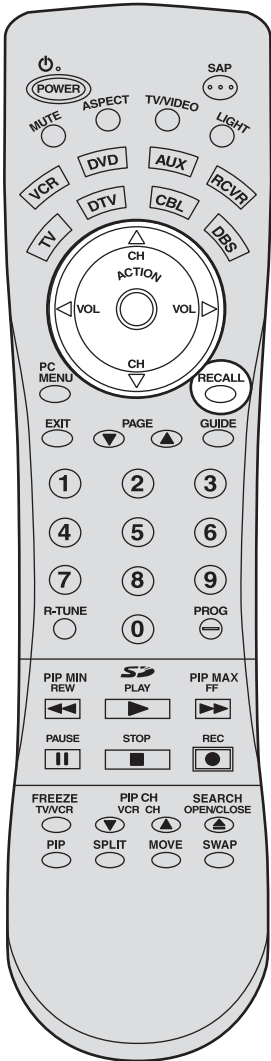

Press the ACTION button to display the MENU screen and select SET UP.

1

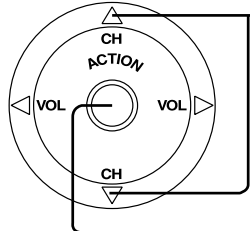

Press to select CHANNEL.

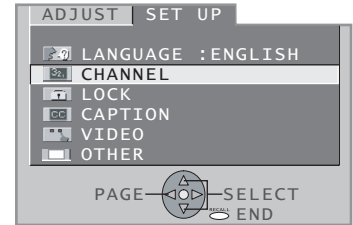

Press to display the SET UP CHANNEL screen.

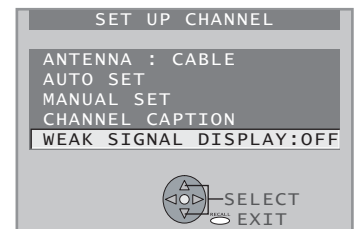

2

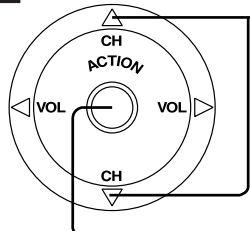

Press to select WEAK SIGNAL DISPLAY.

Press to set "ON" or "OFF".

- ON: Picture is displayed regardless of signal condition, and may not always be clearly visible.
- OFF: Screen turns solid blue when signal is absent or weak. (Screen turns solid black during PIP or SPLIT functions.)

3

RECALL



Press to exit menu.

Note:

If unit is connected to equipment which has blue back feature, selecting "ON" will have no effect on the other equipment.

Video NR (Noise Reduction) Feature

In the event of weak signal conditions, the Video NR circuitry reduces noise in the luminance channel. It is important to note that Video NR should remain OFF for maximum picture detail when receiving a strong signal or viewing high-quality video.



Press the ACTION button to display the MENU screen and select SET UP.

1

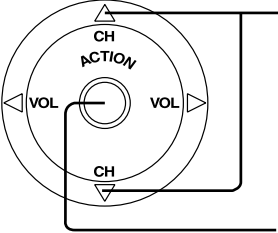

Press to select VIDEO.

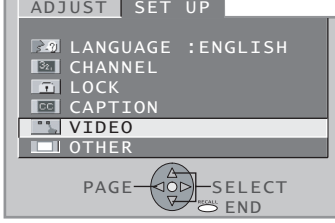

Press to display the VIDEO screen.

2

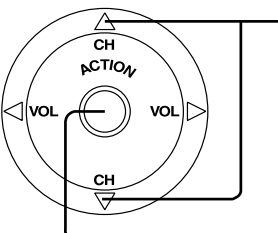

Press to select VIDEO NR.

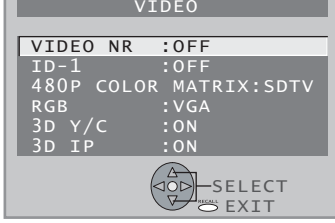

Press to set "ON" or "OFF".

ON: When signal is noisy
OFF: When signal is high-quality

3



Press to exit menu.

Note:
When an RGB/DIGITAL IN signal is input, VIDEO NR is set to OFF only.

Automatically changing screen size

If the received signal contains screen size specifications in RF, VIDEO INPUT (1–3) or COMPONENT VIDEO INPUT (1–4), the screen size is automatically changed.

Press the ACTION button to display the MENU screen and select SET UP.

1

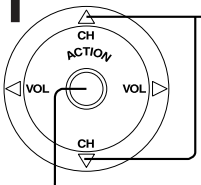

Press to select VIDEO.

Press to display the VIDEO screen.

2

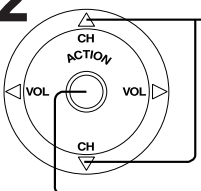

Press to select ID-1.

Press to set "ON" or "OFF".

3



RECALL

Press to exit menu.

Notes:

- When ID-1 is detected and screen size is changed, Aspect mode will be displayed.
- When displaying split screen, ID-1 is not detected.

ON: When screen size specification signals are detected, screen size is automatically changed.

OFF: The screen size is not automatically changed. (Turn OFF if this function does not operate properly.)

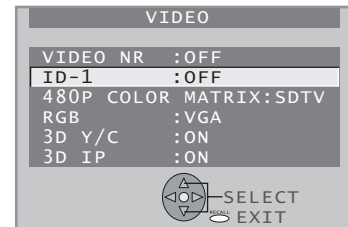
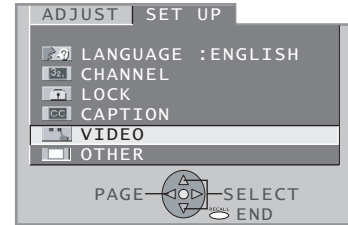

Setting when 480p signals are input through COMPONENT VIDEO INPUT

Adjust 480p signals to achieve a natural color from digital equipment connected to COMPONENT VIDEO INPUT (Y, PB, PR input terminals).

Press the ACTION button to display the MENU screen and select SET UP.

1

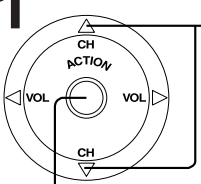

Press to select VIDEO.

Press to display the VIDEO screen.

2

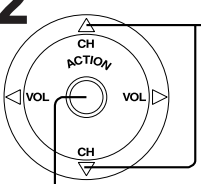

Press to select 480P COLOR MATRIX.

Press to set "SDTV" or "HDTV".

3



RECALL

Press to exit menu.

Note:

480p COLOR MATRIX does not need to be set when using Hi-Definition equipment or 480i output equipment.

SDTV : When the input signal is a normal TV system (NTSC).

HDTV : When the input signal is a High-Definition system (HD).

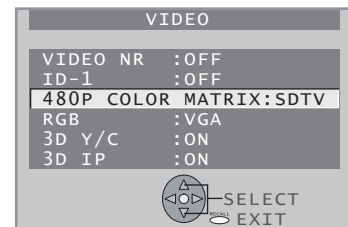
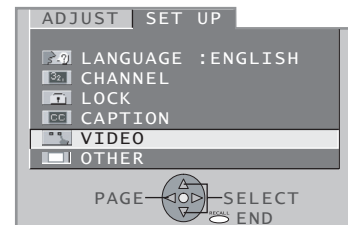

RGB/DIGITAL IN Input Feature

Set the signal to be input to the projection display's RGB IN or DIGITAL IN terminal. Most of analog RGB/DIGITAL IN signals are selected automatically. When RGB/DIGITAL IN input signal is VGA 60Hz from PC or 480P from other equipment, you must manually switch to the desired input.

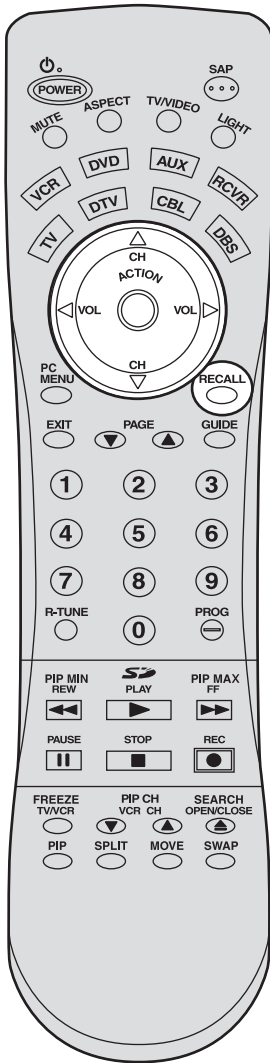

Press the ACTION button to display the MENU screen and select SET UP.

1

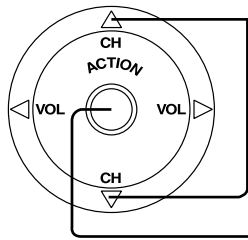

Press to select VIDEO.

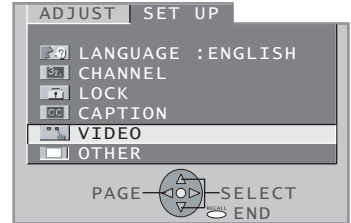

Press to display the VIDEO screen.

2

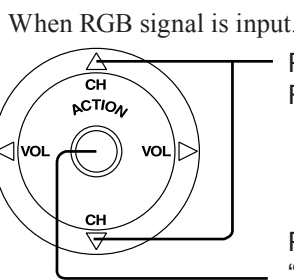

When RGB signal is input.

Press to select RGB.

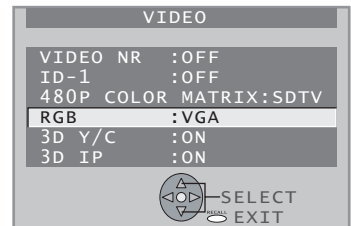

Press to set "VGA" or "480P".

Or

When DIGITAL IN signal is input.

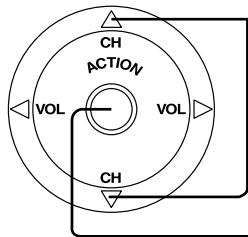

Press to select DIGITAL IN.

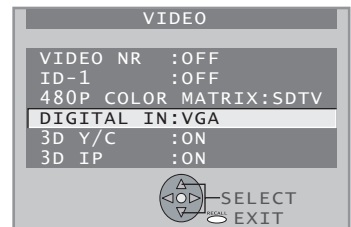

Press to set

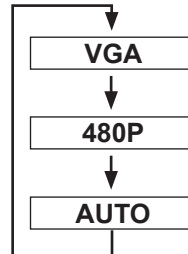

VGA : When RGB/DIGITAL IN input signal is VGA 60Hz from PC.
 480P : When RGB/DIGITAL IN input signal is 480P from other equipment.
 AUTO: VGA/480P input signals are distinguished automatically.
 (DIGITAL IN only)

Note:

Select VGA/480P manually if picture appears unnatural in AUTO.

3

RECALL



Press to exit menu.

3D Y/C Feature

Accurate separation of the picture's brightness and color signals allows you to enjoy a beautiful picture.

Press the ACTION button to display the MENU screen and select SET UP.

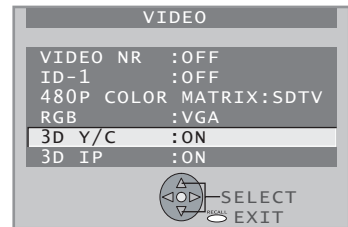
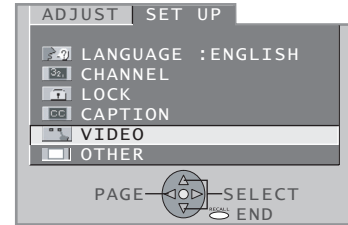
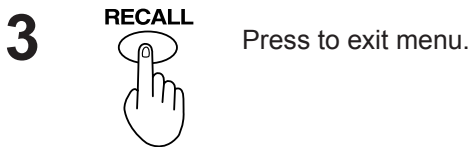
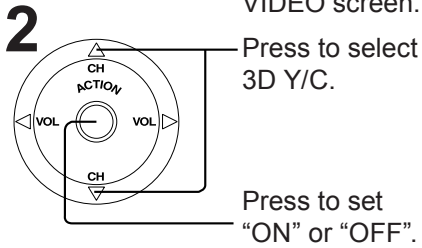
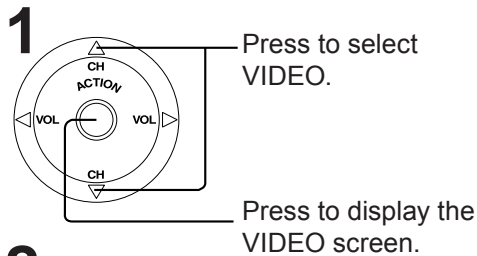

ON: Usually set to ON.
OFF: Set to OFF if picture appears unnatural.

3D IP Feature

Film media (taken at 24 frames per second) is faithfully reproduced on the projection display.

Press the ACTION button to display the MENU screen and select SET UP.

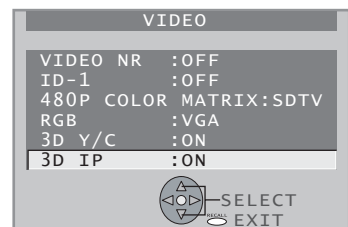
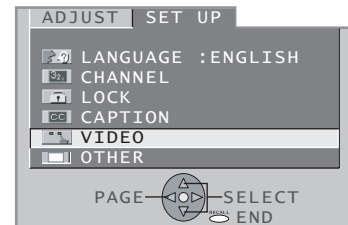
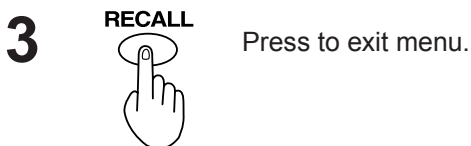
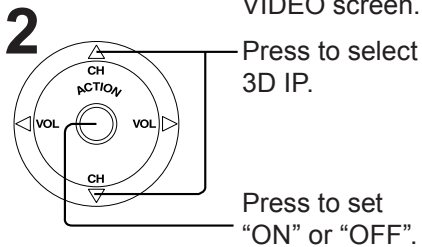
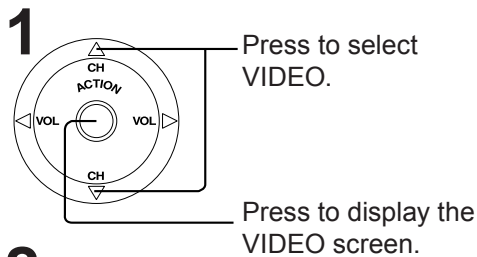

ON: Recordings created at 24 frames per second are shown in higher quality.
OFF: Set to OFF if picture appears unnatural.

Sleep Timer Feature

The projection display can be set to shut itself off at a preselected time.

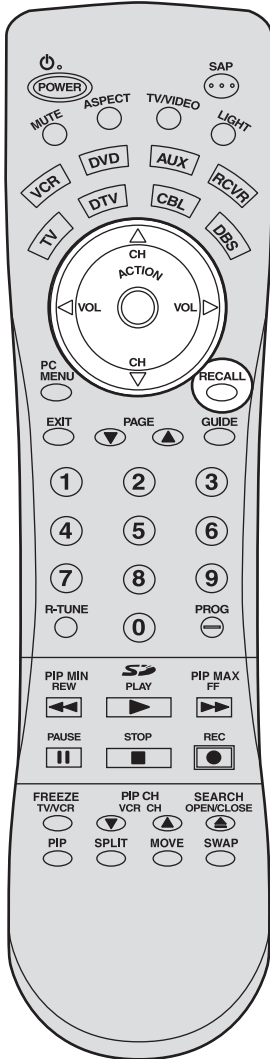

Press the ACTION button to display the MENU screen and select SET UP.

1

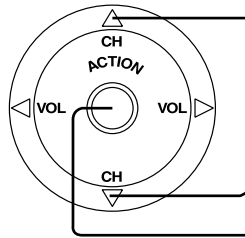

Press to select OTHER.

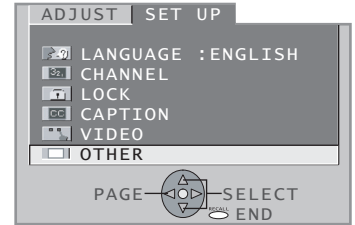

Press to display the OTHER screen.

2

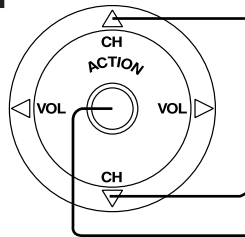

Press to select SLEEP TIMER.

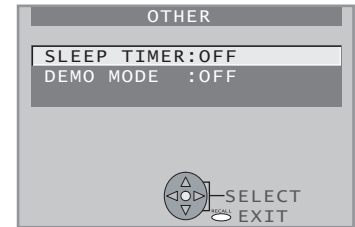

Press repeatedly to select the desired time.

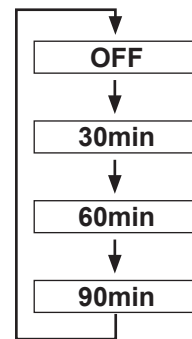

3

RECALL



Press to exit menu.

Note:

- Pressing RECALL with sleep timer set displays remaining time.
- Minutes remaining is displayed for the last 3 minutes before shutoff.

Switching languages for display

The language of the projection display is set to English as the factory setting. To select one of 3 different languages for on-screen displays, follow the instructions below.

Press the ACTION button to display the MENU screen and select SET UP.

1

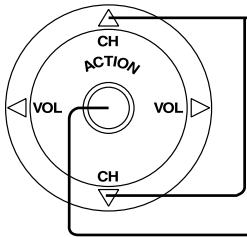

Press to select LANGUAGE.

Press repeatedly to select the desired LANGUAGE.

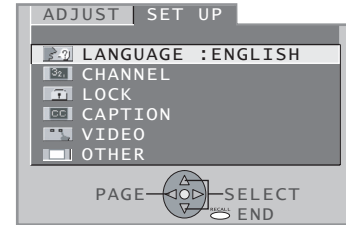
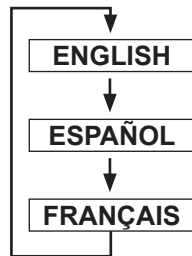

2



Press to exit menu.

Information

You can display the input signal type. Display items differ depending on the input signal.

Press the ACTION button to display the MENU screen and select ADJUST.

1

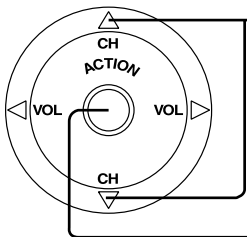

Press to select INFORMATION.

Press to display INFORMATION screen.

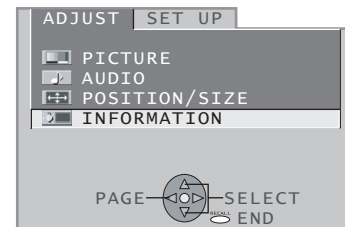

2



Press to exit menu.

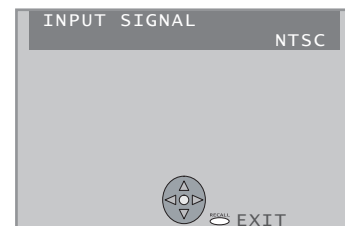

Demo Mode Feature

Function demonstrations of this unit are displayed in Demo mode.

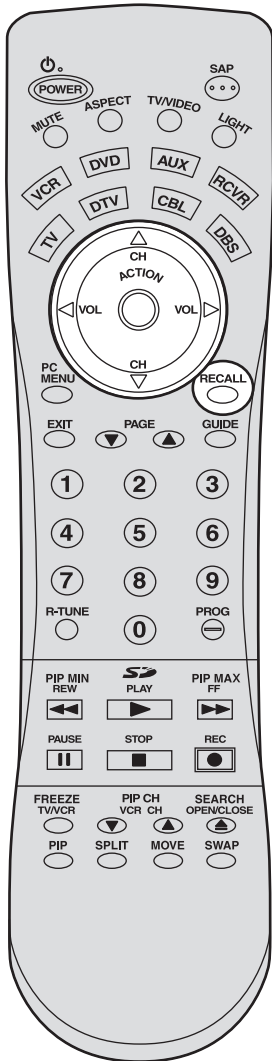

Press the ACTION button to display the MENU screen and select SET UP.

1

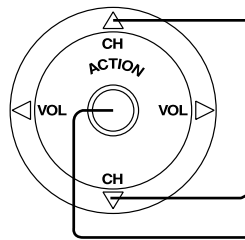

Press to select OTHER.

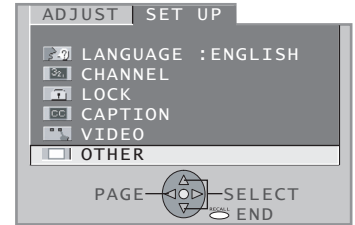

Press to display the OTHER screen.

2

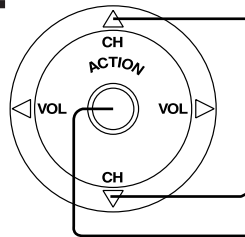

Press to select DEMO MODE.

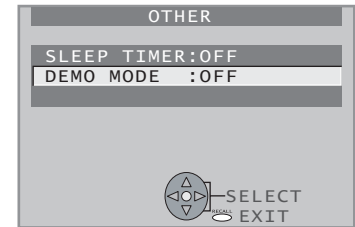

Press to set "ON" or "OFF".

ON: Demo mode is started.
OFF: Demo mode is canceled.

3



Press to exit menu.

Note:

Demo mode setting remains even when power is turned off. To turn off Demo mode, select DEMO MODE : OFF in the menu screen.

JPEG Viewer (SD Card/PC Card)

Still image data (JPEG) made with a digital camera, digital video camera, or PC can be played back using an SD Card/PC Card.

⚠ WARNING

As with any small object, SD cards can be swallowed by young children. Do not allow children to handle the SD card.

Displayable Image Formats:

Baseline JPEG

(80 x 60 ~ 5 120 x 3 840 pixels)

Notes:

- Some parts of an image may not be displayed or the image may be displayed on a smaller scale depending on the size of the image.
- Only JPEG images can be displayed on this projection display.

Card Data Protection

- Do not remove the card while it is being accessed.
- Do not touch the terminals on the back of the SD Card/PC Card.
- Electrical interference, electrostatic discharges and malfunctions of the unit or card may all result in damage to the card or data loss. It is recommended that any important data also be backed up on a PC.
- Stored data should be periodically backed up as a protection against data corruption, data loss or device malfunction. Please note that our company shall not accept any liability for damage or loss of stored data.

Caution

- Always insert card in the correct direction. Failure to do so may result in damage to the card and this unit.
- The SD Card and PC Card are precision devices. Do not subject them to excessive pressure or strong impacts.

Folders and Files

Digital cameras that are compliant with DCF specifications use folders with a specific structure. The following diagram shows an example of the folder structure.

Example:

If the Card file hierarchy is displayed on the PC as shown in diagram at below.

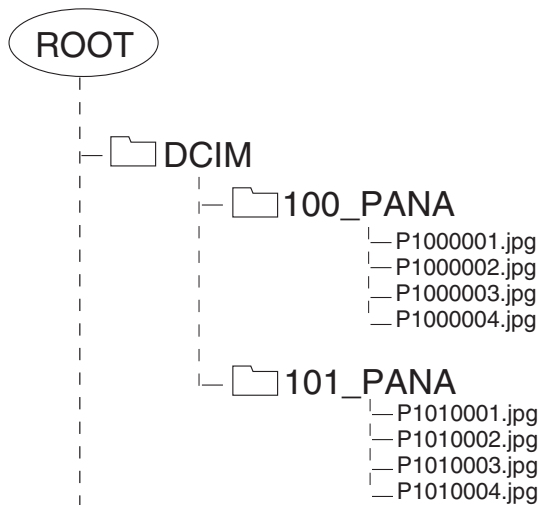

DCIM Folder

The digital camera creates this folder automatically.

100_PANA Folder

Folder names consist of a 3-digit folder number which is followed by five arbitrary characters. Digital camera images are stored within these folders.

JPEG files in the 100_PANA folder are displayed when a Card, which is structured as shown left, is inserted. To display another folder, see page 65 INDEX AREA OPERATION.

Note:

The folder name may vary according to the digital camera being used.

P1000001.JPG: DCF File

File names consist of four arbitrary characters followed by a 4-digit file number. DCF files are image files (normally JPEG files) that have been taken by a digital camera.

JPEG Viewer (SD Card/PC Card)

Insert the Card.

Front Card Slot (P. 10)

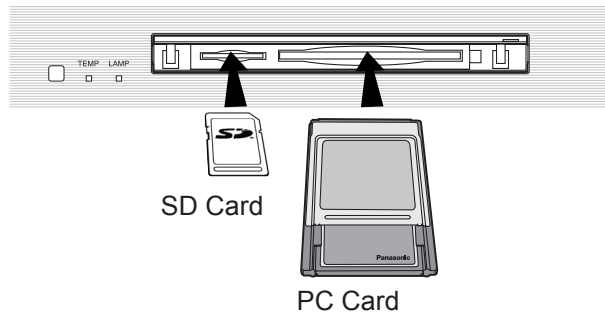

Remove the Card.

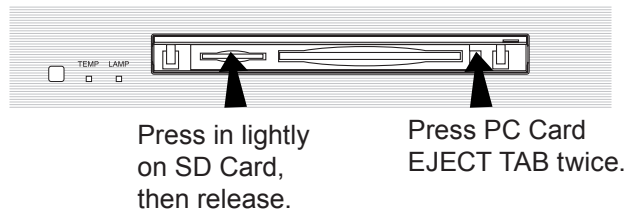

Compatible Card

SD Card slot	PC Card slot
SD Card	Compact Flash*
Multi Media Card	Smart Media*
	Memory Stick*
	xD Picture Card*

- The media* listed in the right column above can be read via the PC Card in the PC Card adaptor.
- Hard disk PC Cards, Flash ATA Cards, and other recorded media cannot be used.
- Place the selected media onto the PC Card and then insert into the PC Card Slot.
- When both an SD Card and PC Card are inserted, the SD Card contents has priority and will be displayed.
- If the Card is unusable, "CARD ERROR" is displayed on-screen. Remove the Card only when ACCESS is not displayed.
- If an incompatible JPEG file is displayed (full size file preview), "DATA ERROR" is displayed.

Notes:

- Insert/remove Card while "Card Menu Screen" or "No Card" is displayed.
- Be sure ACCESS is not displayed before Card insertion/removal.
- Fully insert the Card (ACCESS is displayed). Wait until ACCESS goes out before removing.
- Before reinserting a Card after removing it, wait until "NO CARD" is displayed. If there are Cards in both Card Slots, wait until the Card Menu Screen of the other Slot is displayed and ACCESS is no longer displayed before reinserting a Card.

Card Menu Screen

The screen below is displayed automatically when a card is inserted. If "NO CARD" appears, confirm that a card is correctly inserted.

Parent Folder
Returns currently displayed folder to the parent (previous) folder.

Subfolder
The subfolder of the currently displayed folder is opened.

Display Page No.
When the displayed files/folders fill more than one page, the total number of pages is displayed.

Menu Area
Select display method (SINGLE PLAY or SLIDE SHOW). Confirm the displayed card type (SD Card or PC Card).

ACCESS Indication
ACCESS is displayed while data is read.

Folder Name Area
The name of the selected subfolder (framed in yellow) is displayed.

Index Area
Folders and files are displayed here.

Notes:

- Up to 1 000 JPEG files can be displayed. (This number may be lower if subfolders, or files other than JPEG are included in the folder.)
- Depending on JPEG file type, "JPEG" will be displayed instead of thumbnail image.

Note:
Only JPEG files can be displayed.

JPEG Viewer (SD Card/PC Card)

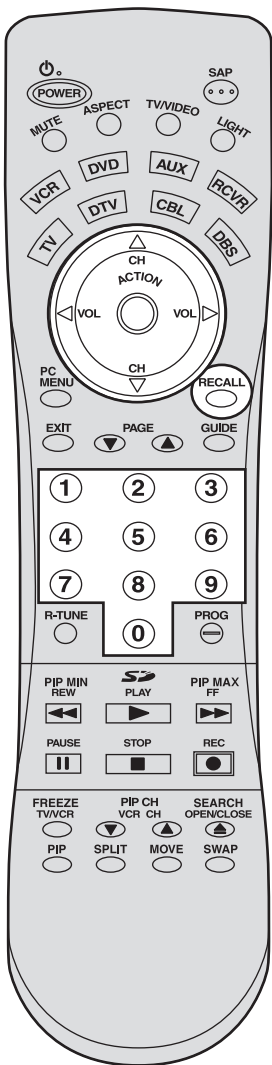

MENU Area Operation

1

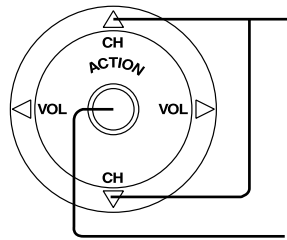

Press to select MENU.

Press to move to index area.

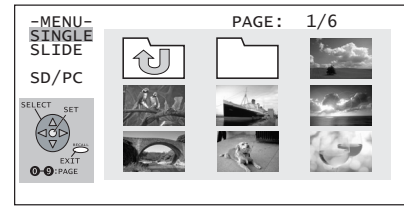

SINGLE

A single image selected from the index area fills the screen. You can also rotate the image and view image information. (PP. 66-67)

SLIDE

Images are displayed one after another as a slide show. Also, the SPEED and Transition features (p. 67) can be used.

SD/PC

When both an SD Card and PC Card are inserted, the ◀▶ buttons can be used to select a card in the index area.

Index Area Operation

2

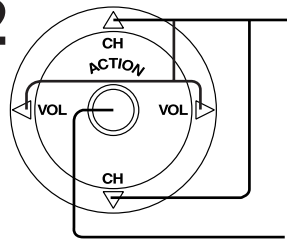

Press to select icon.

Press to set

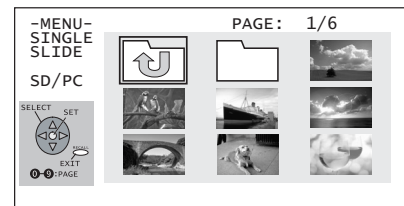

To select a page directly, enter the page number with the Number Keys, then press ACTION.

Select an Image file.

Display full size file preview.

Select a Subfolder (📁).

Display files/folders contained in the folder.

Select a Parent folder (🔙).

Make changes to the parent (previous) directory display.

Note:

File and folder names will not be displayed correctly if...

- More than 8 characters are used.
- Spaces and special symbols are used. Use care when changing file and/or folder names.

RETURN Operation

RECALL



Press RECALL to display RETURN MENU.
Press ▲▼ to select an item, and press ACTION.

RETURN:

Returns to the parent (previous) folder.

RETURN TO MENU:

Returns to Menu Area screen.

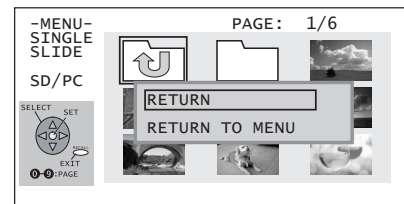

Continued from page 66.

Information Screen Display

Press ACTION: INFORMATION SCREEN is displayed. (Rotation angle is maintained.)

Information Screen



Pressing RECALL returns to SINGLE VIEW SCREEN.

Note:

- If a file name exceeds 8 characters, a file name different from the original is displayed.

Picture Adjustment

When ACTION is pressed while the Information Screen is displayed, the Picture Adjust menu (p. 46) is displayed. (Rotation angle is maintained.)

Picture Adjust menu

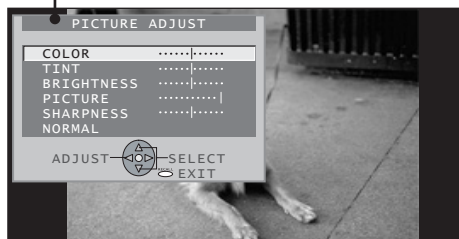

Pressing RECALL returns to SINGLE VIEW SCREEN.

- 2 Press RECALL with SINGLE VIEW screen displayed to return to the Index Area menu.

Slide Show Mode

- 1 Press **▲▼** to select "SLIDE," and press **ACTION**. Press **▲▼◀▶** to move cursor to desired file in Index Area. (Press **▲▼◀▶** to display next/previous page of 9 thumbnail files). Press **ACTION** to display SLIDE MENU. Press **▲▼** to select an item, and press **ACTION** repeatedly to set.

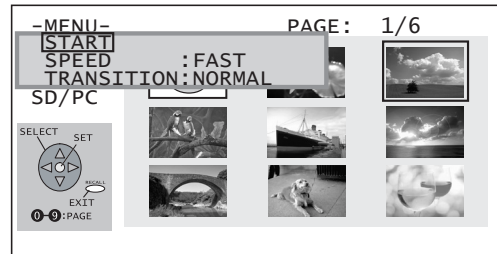

[START]
Starts slide show.

[SPEED]
FAST:
Image transition every 2 seconds.
MEDIUM:
Image transition every 5 seconds.
SLOW:
Image transition every 10 seconds.

Note:

The display intervals of 2, 5, and 10 seconds do not include file data reading time. The display interval becomes longer depending on the JPEG size.

[Transition]
NORMAL:
Image transition one by one.
WIPE:
Image transition from top to bottom.
BLIND:
Image transition in a series of band-like shapes that resemble window blinds.

- 2 **START SLIDE SHOW.**



Press ACTION to stop or resume slide show.

- 3 Press RECALL to exit this mode.

Replacing the lamp unit

The lamp unit is sold separately. To purchase a replacement, call the Panasonic accessory department, toll free at: 1-800-332-5368.

Lamp unit Part No. : TY-LA1000

Lamp unit replacement period

The lamp has a maximum life of about 10 000 hours.

- When the stipulated time is reached, “THE LAMP NEEDS TO BE REPLACED, ...” will be displayed for about 5 minutes.
- The LAMP indicator lights red.

THE LAMP NEEDS TO BE REPLACED, AND THE LAMP HOUR METER NEEDS TO BE RESET.



Due to the characteristics and use conditions of individual lamps, the lamp may cease to light before the stated lamp life.

Influences of frequent lighting, continuous light use for over 24 hours, the number of times lit, the length of time between lightings, etc. may shorten lamp life.

(Because of this, we recommend having a replacement lamp on hand.)

WARNING

Failure to follow these warnings when replacing the lamp unit could result in personal injury:

- 1) The high-pressure lamp could explode if not properly handled and lamp fragments could cause injury.
- 2) Because the temperature of the lamp unit is elevated immediately after its use, touching it may cause burns. Please allow the lamp to cool before handling or replacing the lamp unit.
- 3) Handle the old lamp unit carefully. It can explode if not handled with care.
- 4) Wear gloves and safety eyeglasses when replacing the lamp unit.
- 5) If replacement of the lamp unit becomes necessary during the operation of the TV, follow the procedure below to turn off the power and wait until the lamp unit cools completely.
 - a. Press the POWER button on the remote control unit to turn off the power.
 - b. Wait for about 1 minute until the cooling fan stops.
 - The lamp cooling fan will continue to operate for about 1 minute after turning off the power. Do not unplug the power cord from the outlet until the fan has stopped. Avoid interrupting the power line by using circuit breakers or switchable power strips.
 - c. After the cooling fan has stopped, Unplug the power cord from the outlet.

- Please wait more than one hour for lamp replacement.
[If you need to replace the lamp more urgently]
- The projection display has a forced cooling feature. After the POWER button is turned OFF, and sometime during about the first minute of the normal cooling fan operation, press the VOL+ button on the projection display and the ▲ button on the Remote control at same time for more than 5 seconds. The cooling fan operates for about 10 minutes.

Refer to the instructions enclosed with the lamp unit (Part No.: TY-LA1000) when replacing the lamp.

Remote Control Quick Reference Guide (Operating peripheral equipment)

Programming The Illuminated Remote Control Using Access Codes

The remote control can be preset for other manufacturers, by utilizing the **REMOTE MODE SELECTION BUTTONS** for **CABLE, DTV, VCR, RCVR** (a Receiver or Amplifier), **DVD** (DVD or CD), **DBS** and **AUX** (for **Cassette Player** or a **PVR.**) Details on remote control buttons to operate peripheral equipment. (PP. 74-75)

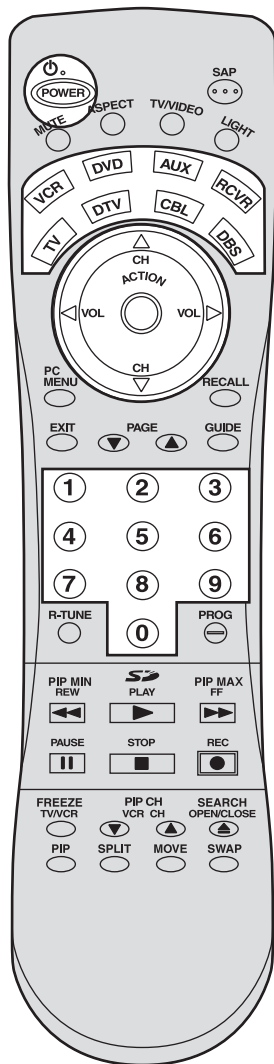

Setting up the remote using the numerical keys.

(When code is known):

1



Press and hold the POWER and ACTION buttons simultaneously **for at least 5 seconds**. After 5 seconds, all the illuminated mode buttons will begin to flash. Then let go of the POWER and ACTION buttons.

+

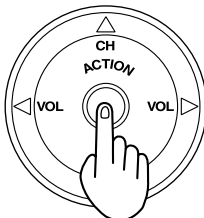

2

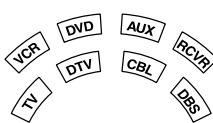

Press the desired mode button. The mode button will illuminate steadily, all others will go out.

3

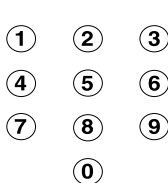

Enter the three digit set up code, by using the Remote Control Keyboard. If the correct code is entered, the mode button will blink twice and then go out. Now your remote is set for this code. Then, press the Remote Control **POWER** button to test the component. If the procedure was successful, the component will turn on.

Device	Operate	Default
TV	TV (Only Panasonic)	Panasonic Code
VCR	VCR (Preset)	Panasonic Code
CBL	Cable Boxes (Preset)	Panasonic Code
DBS	DBS Boxes (Preset)	Panasonic Code
RCVR	RCVR (Preset)	Panasonic Code
AUX	Cassette Players, PVR (Preset)	Panasonic Cassette Players Code
DVD	DVD & LD & CD Player (Preset)	Panasonic DVD Code
DTV	STB (Only Panasonic)	Panasonic Code

Notes:

- Due to changes in infra-red commands used by manufacturers, some brands have several codes. If your unit does not respond to the first code, please try the next one.
- If an incorrect number is entered (or there is an incomplete entry after 30 seconds), the button illumination goes out (no blink) and settings are unchanged.
- Repeat setup after remote battery replacement.
- Remote will not control every component made by the manufacturer listed. If you get no response, your particular component cannot be controlled. There are NO additional codes for the products listed. If your product is not listed, then the remote is not compatible with that product.

Remote Control Quick Reference Guide (Operating peripheral equipment)

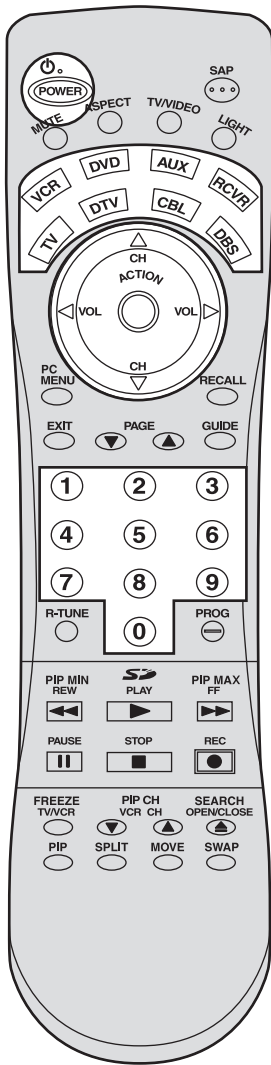

Setting to the remote using the step and set method
(When code is not known):

1



Press and hold the POWER and ACTION buttons simultaneously **for at least 5 seconds**. After 5 seconds, all the illuminated mode buttons will begin to flash. Then let go of the POWER and ACTION button.

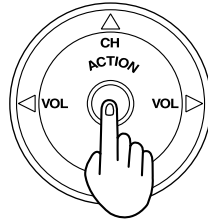

2

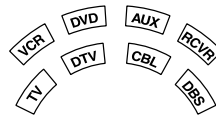

Press the mode button. The mode button will illuminate steadily, all others will go out.

3

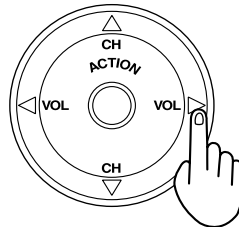

Press “▶” button to step to the next code. Press POWER button to send a test signal in that format. Continue doing this until the proper device code is found, and the target device responds.

4

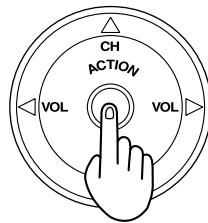

Once the code has been found, press the ACTION button to lock it in.

Notes:

- The step and set mode will start from the current device (not the beginning of the library, except for the first time).
- The step and set mode works in the reverse direction using the “◀” button.

Infrared Remote Codes for Specific Components

Helpful Hint: Write down the code numbers for your components in the space provided below. This will serve as a handy reference whenever you need to reprogram your remote control.

CABLE

Cable Box

VCR

Video Cassette Recorder

CD

Compact Disc Player

DBS

Digital Broadcast System

RCVR

Receiver or Amplifier

DVD

Digital Versatile Player

Other Component

Other Component

Other Component

Other Component

Other Component

Other Component

Remote Control Quick Reference Guide (Operating peripheral equipment)

CABLE CONVERTER BOX AND DVD, CD PLAYERS Infrared Codes Index

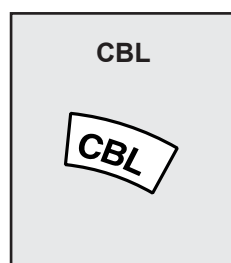

Maker List (CBL)			
Maker	Set Up No.	Maker	Set Up No.
ABC	124	PULSAR	105, 132
ARCHER	125, 132	PUSER	132
CABLEVIEW	105, 132	RCA	115
CITIZEN	105, 122	REALISTIC	132
CURTIS	112, 113	REGAL	112, 118, 140, 141, 142, 145
DIAMOND	124, 125, 132	REGENCY	134
EAGLE	129	REMRANT	105, 132, 137
EASTERN	134	SAMSUNG	105
GCBRAND	105, 132	SCIENTIFIC ATLANTA	111, 112, 113
GEMINI	122	SLMARK	101, 105
GENERAL INSTRUMENT / JERROLD	111, 119, 120, 121, 122, 123, 124, 125, 126, 127	SPRUCER	105, 110
HAMLIN	112, 118, 140, 141, 142, 145	STARGATE	105, 132
HITACHI	103, 124	TELEVIEW	101, 105
MACOM	103, 104, 105	TEXSCAN	144
MAGNAVOX	133	TOCOM	135
MEMOREX	130	TOSHIBA	104
MOVIE TIME	105, 132	UNIKA	125, 132
OAK	102, 137, 139	UNIVERSAL	122, 132
PANASONIC	109, 110, 114	VIDEOWAY	106
PHILIPS	106, 107, 128, 129, 130	VIEWSTAR	129, 130
PIONEER	101, 116	ZENITH	100, 117
		ZENITH / DRAKE SATELLITE	100



Maker List (DVD)			
Maker	Set Up No.	Maker	Set Up No.
DENON	100	SABA	101
FERGUSON	101	SAMSUNG	110
JVC	109	SHARP	108
MITSUBISHI	105	SONY	104
NORDMENDE	101	TECHNICS	100
PANASONIC	100	THOMSON	101
PHILIPS	103	TOSHIBA	103
PIONEER	102	YAMAHA	100
RCA	101	ZENITH	107

Maker List (CD)			
Maker	Set Up No.	Maker	Set Up No.
ADMIRAL	226	OPTIMUS	208, 218, 220, 222
AIWA	233, 235	PANASONIC	224, 225, 227
CARVER	229	PHILIPS	229, 230
DENON	242	PIONEER	208
EMERSON	239	QUASAR	224, 225, 227
FISHER	205	RCA	231, 237, 238, 247
HARMAN/KARDON	219, 220, 221, 223	SANSUI	210, 246
HITACHI	207	SANYO	205
JENSEN	234	SCOTT	210, 246
JVC	240, 241, 245	SHARP	242, 243
KARDON	223	SHERWOOD	220
KENWOOD	200, 201, 211, 245	SONY	228
LXI/SEARS	236	SOUNDESIGN	244
MAGNAVOX	229, 232	TEAC	212, 216, 218
MARANTZ	229	TECHNICS	224, 225, 227
MCINTOSH	221	VICTOR	240, 241, 245
NAKAMICHI	210	YAMAHA	202, 203, 204
ONKYO	214, 215		

Remote Control Quick Reference Guide (Operating peripheral equipment)

CASSETTE PLAYERS, PERSONAL VIDEO RECORDERS, RECEIVERS, AMPLIFIERS, and DBS Infrared Codes Index

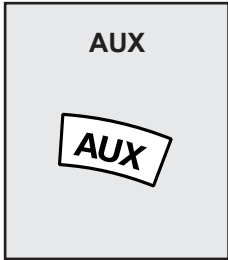

Maker List (TAPE)			
Maker	Set Up No.	Maker	Set Up No.
AIWA	223, 224, 225	PHILIPS	222
DENON	231	PIONEER	204
FISHER	203	RCA	226, 227, 228
JENSEN	214	SANSUI	205, 210
JVC	229, 230	SHARP	231
KENWOOD	200, 207	SONY	219, 220
MARANTZ	202	TEAC	210, 211, 215
NAKAMICHI	205	TECHNICS	216, 218
ONKYO	208, 209, 213	YAMAHA	201, 202
PANASONIC	216, 218		

Maker List (Personal Video Recorders)	
Maker	Set Up No.
Panasonic Replay TV	100
Philips Tivo	101
Sony Tivo 102	102

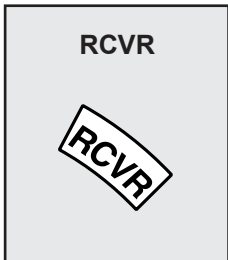



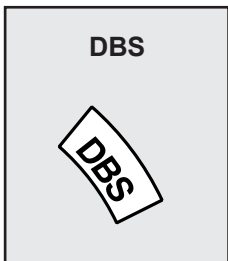









Maker List (RCVR)			
Maker	Set Up No.	Maker	Set Up No.
ADMIRAL	120	OPTIMUS	103, 127, 130, 131
AIWA	125, 126	PANASONIC	118, 119, 121
DENON	134, 135, 136	PHILIPS	123
FISHER	104	PIONEER	105, 107
GARRARD	113	QUASAR	118, 119, 121
HARMAN KARDON	115, 123	RCA	103, 105, 127, 130, 131
JENSEN	129	SANSUI	103, 111, 139
JVC	132, 133	SHARP	134, 137
KENWOOD	100, 108	SONY	122
MAGNAVOX	127	SOUNDESIGN	138
MARANTZ	124	TEAC	111, 112, 113
MCLINTOSH	116	TECHNICS	118, 119, 121
NAKAMICHI	106	VICTOR	132, 133
ONKYO	109, 114	YAMAHA	101, 102

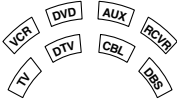
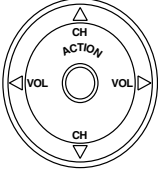

Maker List (DBS)			
Maker	Set Up No.	Maker	Set Up No.
DISH NETWORK	105, 115, 116	MAGNAVOX	101, 102
(ECHOSTAR)		PANASONIC	104
ECHO STAR	105	PHILIPS	101, 102
EXPRESS VU	105, 115	PRIMESTAR	108
G.E.	106	PROSCAN	106, 109, 110, 113
G.I. (GENERAL	108	RCA	106, 109, 110, 113
INSTRUMENT)		SONY	107
GRADIENTE	114	STAR CHOICE	103, 108
HITACHI	103, 111, 112	TOSHIBA	100
HNS (HUGHES)	103	UNIDEN	101, 102

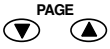

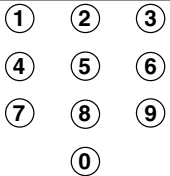







Remote Control Quick Reference Guide (Operating peripheral equipment)

Quick Reference Functional Button Chart

BUTTON	MODE	FUNCTION
	All Components	Turns selected components On and Off
	TV	Press to access Second Audio program
	TV CBL RCVR	Mutes audio
	TV DTV DBS	Select picture size (ratio) to match programming format.
	TV RCVR	Selects the input mode
	Remote Control	Illuminate buttons
	All Components	Component mode selection for remote control
	TV CBL VCR AUX DBS RCVR DTV DVD CD TV CBL RCVR DBS DVD DTV	Channel Up/Down Navigation Up/Down Navigation Up/Down Next/Previous Track Volume (+/-) Navigation Left/Right
	TV DTV CBL DBS DVD	TV Menu DTV Menu Enter DBS Menu Select
	DVD DTV DBS	DVD Menu Menu On/Off Menu On/Off
	DBS DVD	Page Up/Down Skip +/-
	TV CBL VCR DBS DTV AUX (Cassette Deck)	Previous Channel Previous STB Channel Deck A/B
	TV VCR DBS DVD DTV CD	Onscreen Display Onscreen Display Time Format
	TV VCR CBL DBS All Components CD DVD RCVR	Selects Channel Selects Code Selects Track Selects chapter Keys 1, 2, 3 and 4 select A/V inputs; 5 CD; 6 Tuner; 7 Phono; 8 Cassette Deck; 9 Aux
	DTV DBS	Exit Menus
	DTV DBS DVD CD	DTV Guide (Electronic Program Guide) DBS Guide Title Next Disc

Remote Control Quick Reference Guide (Operating peripheral equipment)

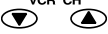
Quick Reference Functional Button Chart

BUTTON	MODE	FUNCTION
 PROG	DTV DBS	Delimiter between major and minor channel number
 PIP MIN REW	TV VCR AUX (Cassette Deck) DVD CD RCVR	PIP Move Rewind Skip Search Fast Rewind Search Fast Rewind Search Fast Rewind Surround (-)
 PLAY	TV VCR AUX (Cassette Deck) DVD CD	PIP On/Off Play Play Play Play
 PIP MAX FF	TV VCR AUX (Cassette Deck) DVD CD RCVR	SPLIT function / PIP Size Fast Forward Fast Forward Skip Search Fast Forward Skip Search Fast Forward Surround (+)
 PAUSE	TV VCR AUX (Cassette Deck) CD DVD	Freeze Pause Pause Still
 STOP	TV VCR DVD CD AUX (Cassette Deck)	PIP Swap / SPLIT swap Stop Stop Stop Stop
 REC	TV DTV VCR AUX (Cassette Deck) DBS	Channel Search Info (EPG) Record Record Record
 FREEZE TV/VCR	VCR DBS	TV/VCR switch TV/DBS switch
 PIP CH VCR CH	TV VCR DVD DBS CD RCVR	PIP Channel Up/Down Channel Up/Down Slow +/- Channel Up/Down Repeat/Random Center Channel (+/-)
 SEARCH OPEN/CLOSE	TV DVD CD AUX (Cassette Deck)	BBE Sound On/Off Open/Close Open/Close Open/Close

Notes:

- Not all functions listed may be controllable.
- Some TV, Cable Box and DSS Receiver brands require you to turn on the power manually.

Troubleshooting

Before you call for service, determine the symptoms and make a few simple checks as shown below.

Symptoms		Checks	Page
Power does not turn ON.		<ul style="list-style-type: none"> Is the power plug plugged in? 	22-23
No picture. (Lamp does not light up.)		<ul style="list-style-type: none"> If the Lamp will not light after turning on the power 2 or 3 times, the Lamp may be damaged. Please consult your nearest dealer. 	68
The power turns OFF.	The POWER indicator flashes orange twice every 5 seconds.	<ul style="list-style-type: none"> The lamp cover is ajar. Firmly replace the cover. 	-
	The TEMP indicator flashes 2 or 4 times every 5 seconds.	<ul style="list-style-type: none"> Check whether or not the vents are clogged. Is the set being used in a location that is hot? 	-
	The TEMP indicator flashes 5 times every 5 seconds.	<ul style="list-style-type: none"> Please consult your nearest dealer. 	-
	Power turns off while another indicator is flashing.	<ul style="list-style-type: none"> Please consult your nearest dealer. 	-
Remote control does not function.		<ul style="list-style-type: none"> Are the batteries dead or inserted incorrectly? 	7
		<ul style="list-style-type: none"> Is the remote control sensor in direct light of fluorescent lamps or other strong sources of light? 	-
		<ul style="list-style-type: none"> Did you correctly set the remote control code? 	69
Image shakes.		<ul style="list-style-type: none"> Is the antenna or antenna cable old, broken or shorted? 	-
Image is not clear.		<ul style="list-style-type: none"> Is the antenna cable connected properly? 	12-14
		<ul style="list-style-type: none"> Sudden changes in ambient temperature may cause condensation in the internal optics. Condensation should disappear after Power has been ON for a while. 	-
Color patches or no color.		<ul style="list-style-type: none"> When using a VCR and selecting channels on the TV, is the TV/VIDEO mode for the VCR set to TV? 	-
Image appears doubled or tripled.		<ul style="list-style-type: none"> Is the antenna facing the right direction? 	-
		<ul style="list-style-type: none"> Is the antenna receiving any signals reflected off of mountains or buildings. 	-
Images disappear at the top and bottom of the screen.		<ul style="list-style-type: none"> When using 16:9 image software, there is no picture at the top and bottom of the screen (cinema vision size software, etc.). 	-
During ZOOM modes, the image is cut off at the top and bottom.		<ul style="list-style-type: none"> Has the screen position been changed? If so, adjust screen positioning. 	32-33, 42-43
Some parts of the screen are always lit while others do not light up. Some parts of the screen do not light up.		<ul style="list-style-type: none"> This is a characteristic of the LCD panel and not a malfunction. 	-
Fan is operating even though TV Power is OFF.		<ul style="list-style-type: none"> This is because the cooling fan is operating. The fan will stop after about 1 minute. 	23
An OSD instructing to replace the lamp is displayed. (The LAMP indicator is lit red.)		<ul style="list-style-type: none"> Replace lamp with a new one. 	68
Relighting the lamp when it is hot makes a sound.		<ul style="list-style-type: none"> This is a characteristic of the lamp and not a malfunction. 	-
Leaving stationary images, such as still video images, web pages, or filler bars (used for NORMAL aspect mode), on-screen for an extended period of time can leave ghost images on the screen.		<ul style="list-style-type: none"> This is a characteristic of the LCD panel and not a malfunction. Try displaying constantly moving pictures which fill the entire screen, or turn the power OFF for a while to return the screen to normal. 	-
An OSD advising "AIR FILTER CLEANING..." is displayed.		<ul style="list-style-type: none"> Please consult your nearest dealer. 	-

Specifications



		PT-50LC13	PT-60LC13
Power Source		AC 120 V, 60 Hz	
Power Consumption		Power ON: Approx. 220 W (When audio is at maximum) Power OFF: Approx. 0.4 W (When cooling fan is stopped)	
LCD panels		0.9" Poly silicon TFT LCD panel x 3 921 600 (1 280 x 720) stripe pixels x 3 panels (16:9)	
Display		50-inch, 16 : 9 aspect ratio	60-inch, 16 : 9 aspect ratio
Speaker		2 Speakers 30 W [15 W + 15 W] (10 % THD)	
HID Lamp		100 W HID (High Intensity Discharge) Lamp	
Channel Capability		VHF-12 : UHF-56 : Cable-125	
Input Terminals	RGB INPUT 1-2	RGB analog AUDIO	0.7 Vp-p (75 Ω) (D-SUB15P) 0.5 Vrms (M3 Stereo mini Pin Jack)
	AV INPUT 1-3	VIDEO S-VIDEO AUDIO L-R	1.0 Vp-p (75 Ω) (RCA Pin Jack) Y : 1 Vp-p (75 Ω), C : 0.286 Vp-p (75 Ω) (Mini DIN 4 pin) 0.5 Vrms (RCA Pin Jack x 2)
	COMPONENT VIDEO INPUT 1-4	Y PB / PR AUDIO L-R	1.0 Vp-p (with sync) (75 Ω) (Pin Jack) ± 0.35 Vp-p (75 Ω) (Pin Jack x 2) 0.5 Vrms (RCA Pin Jack x 2)
	DIGITAL IN INPUT	DIGITAL IN AUDIO L-R	DVI 1.0 (24 pin) 0.5 Vrms (RCA Pin Jack Type × 2)
Card slot	SD Card slot	SD Card, Multi Media Card	
	PC Card slot	Compact Flash, Smart Media, Memory Stick, xD Picture Card	
Output signals (AV OUT)		VIDEO S-VIDEO AUDIO L-R	1.0 Vp-p (75 Ω) (RCA Pin Jack) Y : 1 Vp-p (75 Ω), C : 0.286 Vp-p (75 Ω) (Mini DIN 4 pin) 0.5 Vrms (RCA Pin Jack x 2)
Dimensions (W x H x D)		1 416 mm (W) x 897 mm (H) x 389 mm (D) 55-6/8" (W) x 35-5/16" (H) x 15-5/16" (D)	1 637 mm (W) x 1 050 mm (H) x 459 mm (D) 64-7/16" (W) x 41-3/8" (H) x 18-1/16" (D)
Weight (Mass)		37.6 kg (82.9 lbs.) Net	46 kg (101.4 lbs.) Net
Operating conditions		Temperature : 0 °C – 40 °C (34 °F - 104 °F) Humidity : 20 % - 80 % (non-condensing)	

Note:

Design and Specifications are subject to change without notice. Weight and Dimensions shown are approximate.

Cleaning

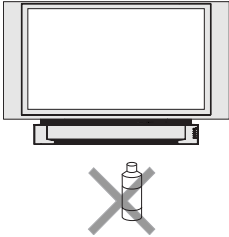
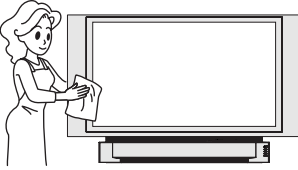
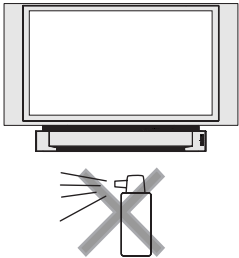
To ensure continued excellent performance by this product, periodic cleaning is recommended.

	<p>The unit contains many plastic parts. For this reason DO NOT use benzine, thinner or other chemicals to clean the unit.</p>		<p>Dust will accumulate on the picture screen. Please wipe with a soft cloth from time to time. If you use a chemically treated cloth, please be careful to follow the instructions that come with the cloth.</p>
	<p>DO NOT bring into contact with insecticide or other volatile substances. DO NOT allow the unit to come into contact for extended periods with rubber or vinyl products.</p>		<p>Remove dirt and soiling by wiping with a light cloth. Even if the unit is heavily soiled, do not apply cleaner directly to the unit. Soak a cloth in a solution of neutral cleanser diluted with water. Then wring out the cloth, wipe the unit clean, and finish by wiping with a dry cloth. Do not use any type of cleansers on the picture screen.</p>

Customer Services Directory

For Product Information, Operating Assistance, Literature Request, Dealer Locations, and Customer Service inquiries please visit Web Site:

<http://www.panasonic.com>

You can purchase parts, accessories, locate your nearest servicenter and more by visiting our Web Site.

or E-mail us via web:

http://www.panasonic.com/consumer_electronics/support/customerfeedback.asp

Contact:

1-800-211-PANA (7262),

Monday-Friday 9 am-9 pm; Saturday-Sunday 10 am-7 pm, EST.

For hearing or speech impaired TTY users, TTY : 1-877-833-8855

Accessory Purchases

1-800-332-5368 (Customer Orders Only)

1-800-237-9080 (Fax Only)

(Monday-Friday 9 am-8 pm, EST.) Panasonic Services Company

20421 84th Avenue South, Kent, WA 98032

(Accepts Visa, MasterCard, Discover Card, American Express, and Personal Check)

<http://www.pasc.panasonic.com> or email to parts@panasonic.com

For hearing or speech impaired TTY users, TTY : 1-866-605-1277

Service in Puerto Rico

Matsushita Electric of Puerto Rico, Inc. Panasonic Sales Company/ Factory Servicenter:

Ave. 65 de Infantería, Km. 9.5, San Gabriel Industrial Park, Carolina, Puerto Rico 00985

Phone (787)750-4300 Fax (787)768-2910

As of May 2003

Limited Warranty

PANASONIC CONSUMER
ELECTRONICS COMPANY, DIVISION
OF MATSUSHITA ELECTRIC
CORPORATION OF AMERICA
One Panasonic Way
Secaucus, New Jersey 07094

PANASONIC SALES COMPANY,
DIVISION OF MATSUSHITA
ELECTRIC OF PUERTO RICO, INC.,
Ave. 65 de Infantería, Km. 9.5
San Gabriel Industrial Park, Carolina,
Puerto Rico 00985

Panasonic Multimedia Projection Display Limited Warranty

Limited Warranty Coverage

If your product does not work properly because of a defect in materials or workmanship, Panasonic Consumer Electronics Company or Panasonic Sales Company (collectively referred to as “the warrantor”) will, for the length of the period indicated on the chart below, which starts with the date of original purchase (“warranty period”), at its option either (a) repair your product with new or refurbished parts, or (b) replace it with a new or a refurbished product. The decision to repair or replace will be made by the warrantor.

CATEGORY	PARTS	LABOR	SERVICE
Multimedia Projection Display	One (1) Year	One (1) Year	In-Home or Carry-In

During the “Labor” warranty period there will be no charge for labor. During the “Parts” warranty period, there will be no charge for parts. You must carry-in your product or arrange for in-home service during the warranty period. If non-rechargeable batteries are included, they are not warranted. This warranty only applies to products purchased and serviced in the United States or Puerto Rico. This warranty is extended only to the original purchaser of a new product which was not sold “as is”. A purchase receipt or other proof of the original purchase date is required for warranty service.

Carry-in or In-Home Service

For In-Home or Carry-In Service in the United States call 1-888-VIEW-PTV (1-888-843-9788).

For assistance in Puerto Rico call Panasonic Sales Company (787)-750-4300 or fax (787)-768-2910.

In-Home service requires clear, complete and easy access to the product by the authorized servicer and does not include removal or re-installation of an installed product. It is possible that certain in-home repairs will not be completed in-home, but will require that the product, or parts of the product, be removed for shop diagnosis and/or repair and then returned.

Limited Warranty Limits And Exclusions

This warranty ONLY COVERS failures due to defects in materials or workmanship, and DOES NOT COVER normal wear and tear or cosmetic damage. The warranty also does not cover damages which occurred in shipment, or failures which are caused by products not supplied by the warrantor, or failures which result from accidents, misuse, abuse, neglect, mishandling, misapplication, alteration, faulty installation, set-up adjustments, misadjustment of consumer controls, power line surge, lightning damage, modification, or commercial use (such as in a hotel, office, restaurant, or other business), rental use of the product, service by anyone other than a Factory Servicenter or other Authorized Servicer, or damage that is attributable to acts of God.

THERE ARE NO EXPRESS WARRANTIES EXCEPT AS LISTED UNDER “LIMITED WARRANTY COVERAGE”. THE WARRANTOR IS NOT LIABLE FOR INCIDENTAL OR CONSEQUENTIAL DAMAGES RESULTING FROM THE USE OF THIS PRODUCT, OR ARISING OUT OF ANY BREACH OF THIS WARRANTY. (As examples, this excludes damages for lost time, cost of having someone remove or re-install an installed unit if applicable, or travel to and from the servicer. The items listed are not exclusive, but are for illustration only.) **ALL EXPRESS AND IMPLIED WARRANTIES, INCLUDING THE WARRANTY OF MERCHANTABILITY, ARE LIMITED TO THE PERIOD OF THE LIMITED WARRANTY.**

Some states do not allow the exclusion or limitation of incidental or consequential damages, or limitations on how long an implied warranty lasts, so the exclusions may not apply to you.

This warranty gives you specific legal rights and you may also have other rights, which vary, from state to state. If a problem with this product develops during or after the warranty period, you may contact your dealer or Servicenter. If the problem is not handled to your satisfaction, then write to the warrantor's Consumer Affairs Department at the addresses listed for the warrantor.

PARTS AND SERVICE (INCLUDING COST OF AN IN-HOME SERVICE CALL, WHERE APPLICABLE) WHICH ARE NOT COVERED BY THIS LIMITED WARRANTY ARE YOUR RESPONSIBILITY.

Index

1 080 i.....	16, 21
480 i.....	16, 21
480 p.....	16, 21
720 p.....	16, 21

A

ACTION button.....	9, 24
ASPECT button.....	9, 32
Auto shut off.....	31
AV out terminals.....	11

B

BBE.....	45
Blocking Message.....	51

C

Card MENU SCREEN.....	64
Channel up / down buttons (projection display).....	10, 30
CH buttons (remote control).....	9, 24
Component signal input terminals.....	11

D

Digital Input terminal.....	11
DIGITAL IN position.....	35
DVI cable.....	20

F

Freezing pictures.....	36
Function buttons.....	8

I

ID-1.....	57
Input 1, 2, 3 terminals.....	11

L

LAMP indicator.....	10
Left screen.....	38
Light button.....	9

M

Main picture.....	38, 40
Main screen.....	40
Mode Selection buttons.....	8
MUTE button.....	8

N

Number keys.....	8, 31
------------------	-------

P

PC Card.....	64
PIP screen.....	40
POWER button.....	8, 22
POWER button/POWER indicator.....	10, 23, 30

R

R-TUNE button.....	8
RECALL button.....	9, 25, 31
Receivable Broadcast Types.....	37
Remote Control Sensor.....	10, 30
Reset User's Memory Functions.....	51
RGB 1, 2 positions.....	35
RGB cable.....	18, 19
RGB IN 1, 2 terminals.....	11
Right screen.....	38

S

SAP button.....	9
SD Card.....	64
Sound mute.....	36
SVGA.....	21

T

TEMP indicator.....	10
TV/VIDEO button.....	9, 35

U

Using stereo system.....	17
Using VCR.....	14

V

VESA.....	21
VGA.....	21
VHF/UHF terminal.....	11
Volume +/- buttons (projection display).....	10, 30
VOL buttons (remote control).....	9, 24

X

XGA.....	21
----------	----

Y

Y, PB, PR.....	16
----------------	----

Customer' Record

The serial number of this product can be found on its back cover. You should note this serial number in the space provided below and retain this book, plus your purchase receipt, as a permanent record of your purchase to aid in identification in the event of theft or loss, and for Warranty Service purposes.

Model Number

Serial Number

Panasonic Consumer Electronics Company, Division of Matsushita Electric Corporation of America
One Panasonic Way Secaucus New Jersey 07094

Panasonic Sales Company, Division of Matsushita Electric of Puerto Rico Inc. ("PSC")
Ave. 65 de Infanteria, Km 9.5 San Gabriel Industrial Park, Carolina, Puerto Rico 00985